

Alternative Interior Decoration



tahuma

2012 Latest Collection

ma



tahuma
Alternative Interior Decoration



Tahuma s.r.l.
23815 Introbio (LC) Italy
P.za Cavour, 14
P.O.Box 55 / C.P.55
Tel. +39 0341 981535
Fax +39 0341 982707
www.tahuma.it
info@tahuma.it

tahuma

Alternative Interior Decoration



ta

tahuma

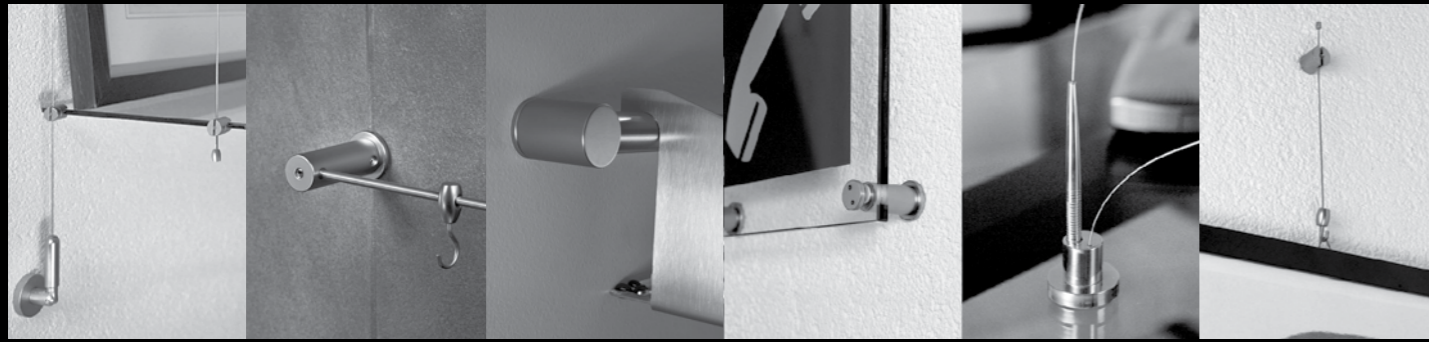

Sistemi a cavo	Sistemi a barra	Sistemi a tubo	Elementi di supporto	Oggettistica	Sistemi espositivi
Cable systems	Bar systems	Tube systems	Supports	Objects	Displaying systems
Drahtseilsystem	Stabsystem	Rohrsystem	Trägerelemente	Gegenstände	Ausstellsystem
Système par câble	Système par barre	Système tubulaire	Éléments de support	Gadgets	Systèmes d'exposition

Sistema ad elementi collegati per arredo, esposizione e comunicazione
Connected elements system for furniture, communication and displaying
Systemelemente für die Inneneinrichtung, Verkaufs- und Ladenausstattung und Kommunikation
Système à éléments assemblés pour aménagement, exposition et communication

Alternative Interior Decoration



Alternative Interior Decoration 003 →

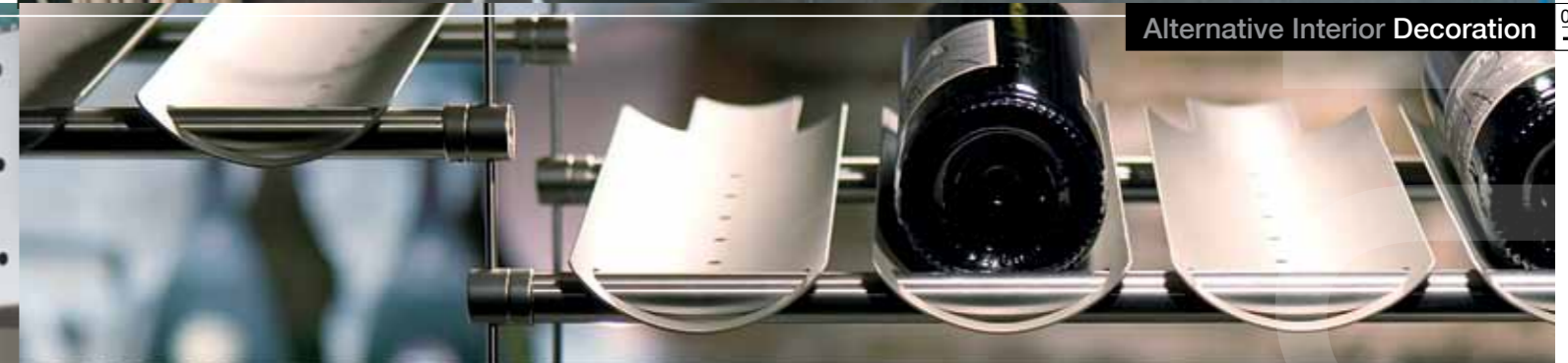

Alternative Interior Exposition 093 →



Alternative Interior Lighting 105 →



000
000 → Numero di pagina del catalogo
Catalogue page number
Katalogseite
Numéro de page

! → Verificare le caratteristiche del prodotto e le condizioni di utilizzo sul manuale tecnico.
Check product information and using instructions on the technical handbook.
Produkteigenschaften und Gebrauchsbedingungen im technischen Handbuch prüfen.
Vérifier les caractéristiques du produit et ses conditions d'utilisation dans le manuel technique.



000
000 → Identificativo prodotto
Product reference mark
Produktidentifikation
Identification du produit

Tahuma ha ideato, progettato e prodotto sistemi ad elementi collegati con cavi, barre e tubi la cui estrema flessibilità di utilizzo permette un'ampia scelta compositiva anche ad installazione avvenuta. Alla base dei sistemi Tahuma è l'idea di utilizzare la creatività e lo spazio, per progettare arredamenti che si adattino ad ogni esigenza. Utilizzare lo spazio diviene l'occasione per creare più spazio, dove occorrono funzioni di servizio e qualità estetica grazie anche ai materiali e alle finiture di elevato standard.

Tahuma designs and produces connected element systems with cables, bars and tubes that allow flexibility of use even after installation. The concept of the systems is the idea of using space in a creative way, to design a wide variety of interior design ambients using high quality materials and finishings.

Tahuma hat mit Drahtseilen, Stäben und Rohren Systemelemente entworfen und entwickelt, das sich den individuellen Wünschen und Räumen und wechselnden Bedürfnissen auch nach erfolgter Montage optimal anpasst. Tahuma benutzt Kreativität und Räumlichkeiten, um Einrichtungen zu entwickeln, die sich allen Anforderungen anpassen. Die optimale Nutzung der Räumlichkeiten bietet die Möglichkeit mehr Platz zu schaffen, wo funktionsgerechte und optisch reizvolle Lösungen mit hochqualitativen Materialien und Beschichtungen benötigt werden.

Tahuma a conçu, créé et réalisé des systèmes à éléments assemblables par câbles, barres et tubes dont l'extrême souplesse d'utilisation permet un vaste choix de composition même après installation. A la base des systèmes Tahuma, il y a l'idée d'utiliser la créativité et l'espace afin de créer des agencements qui s'adaptent à toutes les exigences. Utiliser l'espace devient l'occasion de créer plus d'espace exigeant des fonctions de service et de qualité esthétique en partie obtenues grâce à des matériaux et des finitions au standard élevé.





Allestire spazi commerciali con il sistema Gustavo è semplice e pratico grazie alla possibilità di spostare gli elementi appesi in base alle nuove esigenze espositive.

Setting up commercial spaces with Gustavo it's simple and practical: you can adjust the hanging elements to fulfil your requirements.

Geschäftsräume mit dem System Gustavo auszustatten ist einfach und praktisch, da man die Hängeelemente an die Anforderungen der auszustellenden Ware anpassen kann.

Equiper des espaces commerciaux du système Gustavo c'est simple et pratique: vous pouvez déplacer les éléments accrochés par rapport à vos exigences d'exposition.

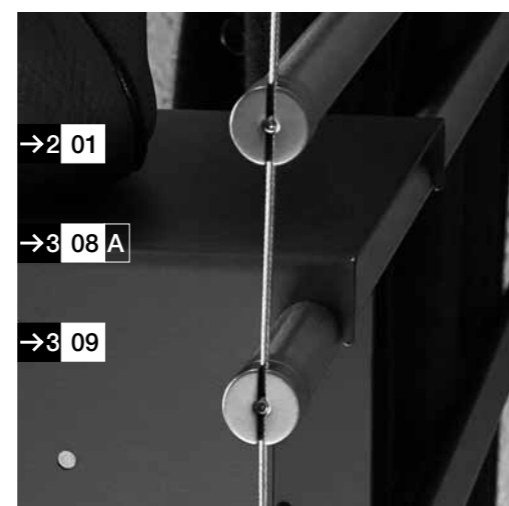

Configurare gli spazi con sistemi leggeri e permeabili alla vista e allestire vani, nicchie o strutture mobili consentendo uno sfruttamento dello spazio razionale ed esteticamente efficace. Con Gustavo è possibile allestire pareti attrezzate anche dove non ci sono, è possibile esporre oggetti, raccogliere cd, dvd o libri.

Shaping spaces with light, sight-permeable systems and setting up spaces, niches or racks in order to get the most of space in a rational and aesthetically effective way. With Gustavo it is possible to set up wall units even where there's no wall, it is possible to display objects, collect cd, dvd and books.

Räumlichkeiten mit leichten und transparenten Systemen gestalten und Räume, Nischen oder Möbelstrukturen ästhetisch ansprechend und praktisch zugleich einrichten. Mit Gustavo kann man ausgestattete Wände auch dort wo keine sind einrichten, Gegenstände ausstellen, CD, DVD und Bücher aufbewahren.

Configurer les espaces avec des systèmes légers et perméables à la vue et aménager espaces, niches ou structures mobiles permettant d'exploiter l'espace d'une façon rationnelle et esthétiquement efficace. Grâce à Gustavo, il est possible d'agencer des murs équipés même quand il n'y en a pas, il est possible d'exposer des objets, de ranger CD, DVD ou livres.

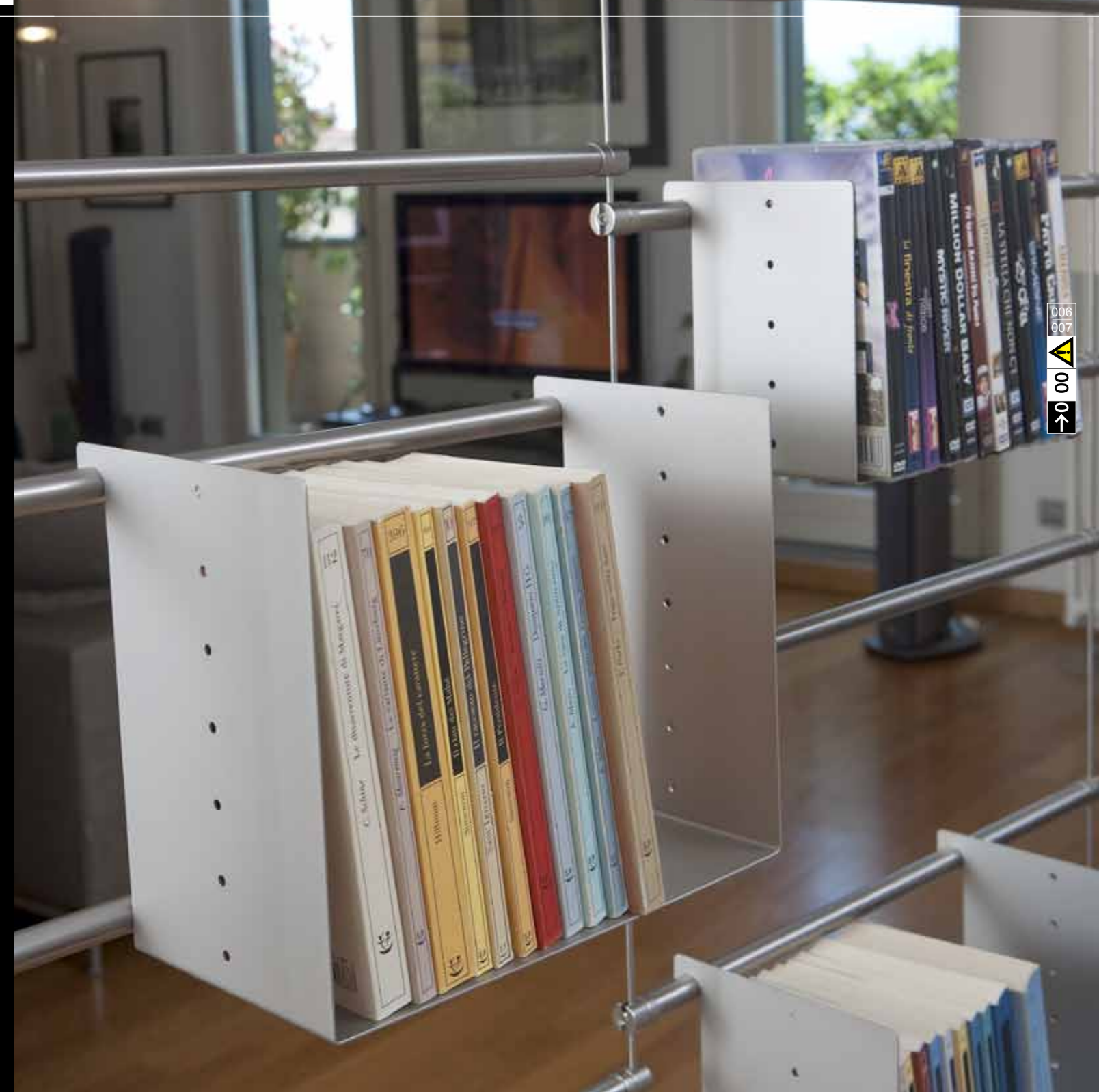
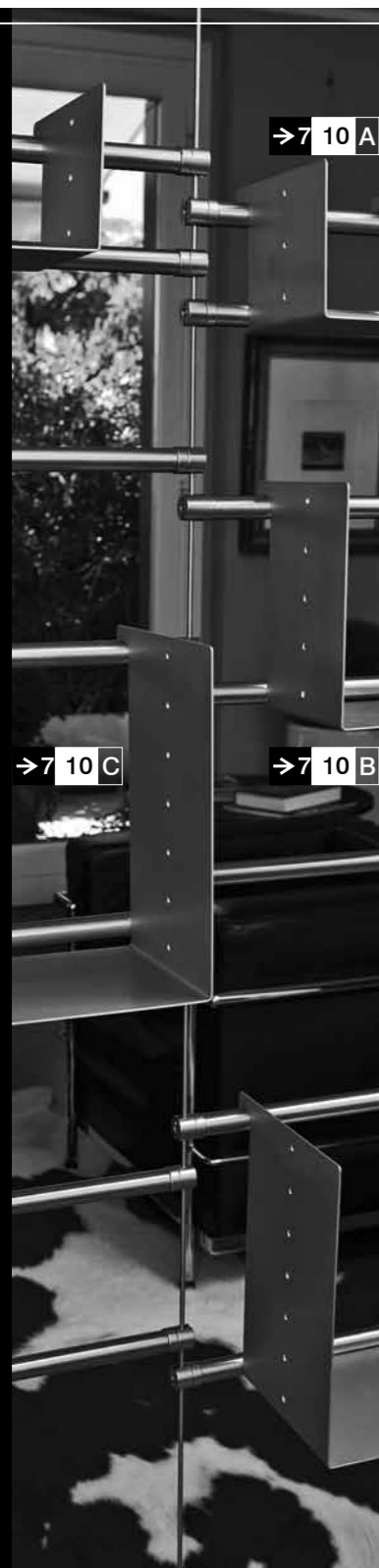

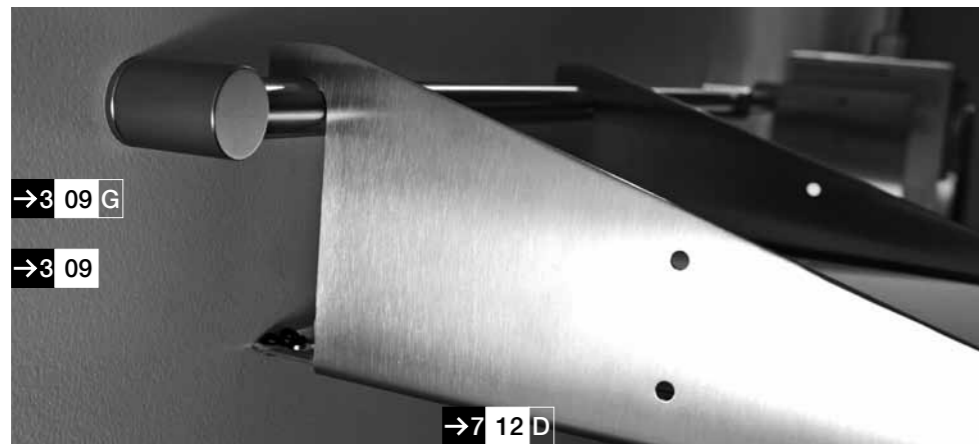

L'evoluzione del sistema Gustavo nella versione Wall soddisfa tutte quelle esigenze di utilizzo degli spazi a parete, permettendo la riconfigurazione degli elementi ogni qualvolta le necessità professionali o personali lo richiedano.

The evolution of Gustavo system in the wall version satisfies all needs of use of wall spaces: these elements can be shaped according to your professional or personal needs.

Mit der Weiterentwicklung des Systems Gustavo in der Ausführung Wall können Sie auch Wände sinnvoll einrichten und ausnutzen. Die Elemente können jeder Zeit den neuen professionellen und persönlichen Anforderungen angepasst werden.

L'évolution du système Gustavo dans la version Wall répond à toutes ces exigences d'usage des parois, en permettant d'adapter les éléments à vos nécessités professionnelles ou personnelles.

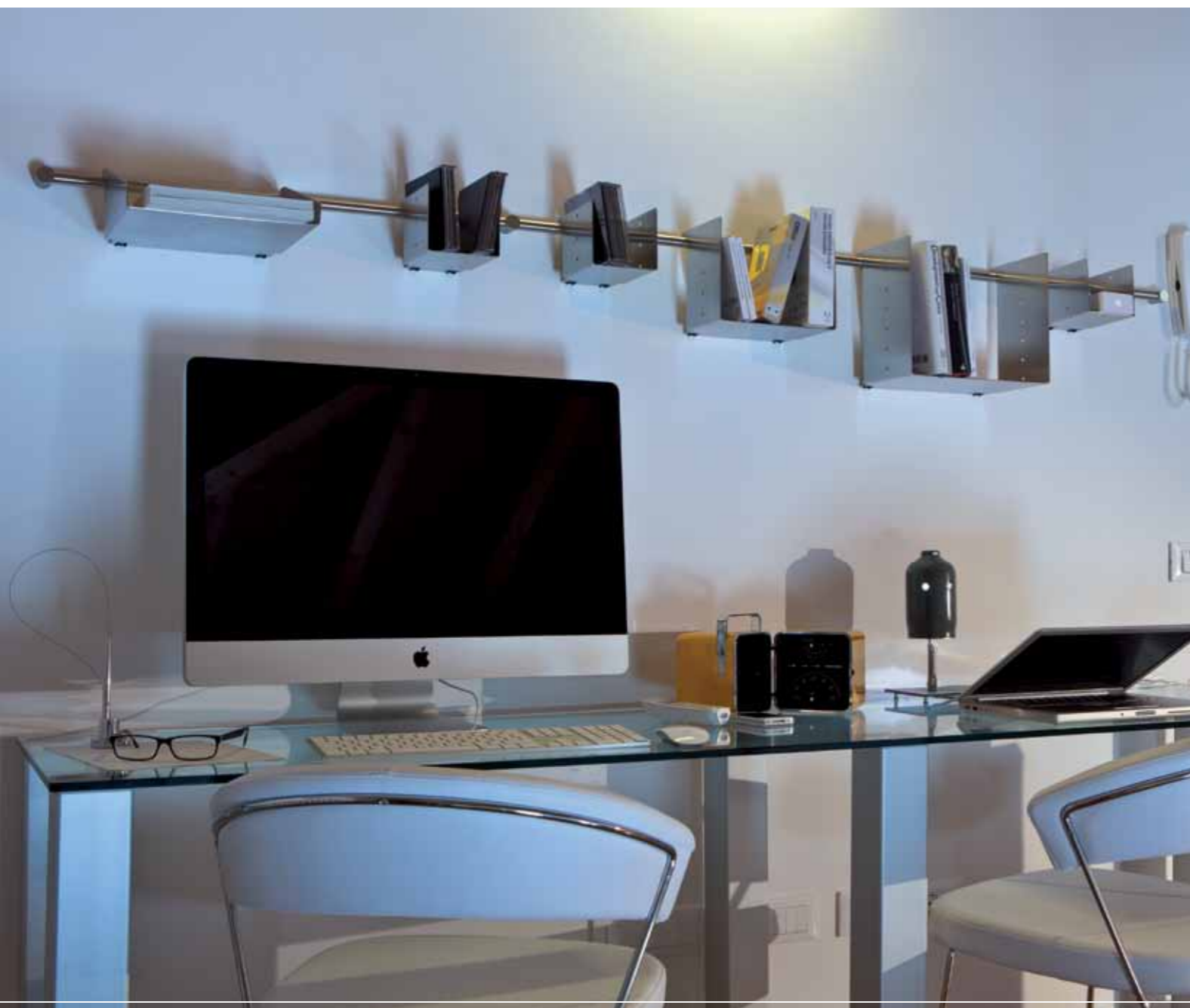

Massima versatilità per allestire spazi adibiti alla conservazione e alla presentazione delle bottiglie sia in ambienti domestici (cucina, zona bar, cantina) che in ambienti commerciali (enoteche, wine bar, negozi, ristoranti, fiere), creando in maniera semplice e veloce composizioni d'effetto, personalizzate e facilmente riconfigurabili.

The system allows maximum versatility to set up spaces used to preserve and present bottles both in domestic ambients (kitchen, bar, wine cellar) and in commercial activities (wine store, wine-bars, restaurants, fairs), creating in a simple and quick way a lot of sensational, customised and easily rearrangeable compositions.

Maximale Vielseitigkeit, um Konversationsecken auszustatten oder Flaschen zu Hause (Küche, Bar, Keller) und an kommerziellen Orten (Weinhandlungen, Weinlokale, Geschäften, Restaurants, Messen) auf elegante Weise anzubieten. Auf einfache und schnelle Weise werden effektvolle, personalisierte und einfach gestaltbare Strukturen geschaffen.

Flexibilité majeure pour aménager des espaces destinés à la conservation et à la présentation des bouteilles dans des lieux aussi bien à usage ménager (cuisine, zone bar, cave) que commercial (œnothèques, bars à vins, boutiques, restaurants, salons d'exposition), créant de façon simple et rapide des compositions d'effets, personnalisées et facilement reconfigurables.

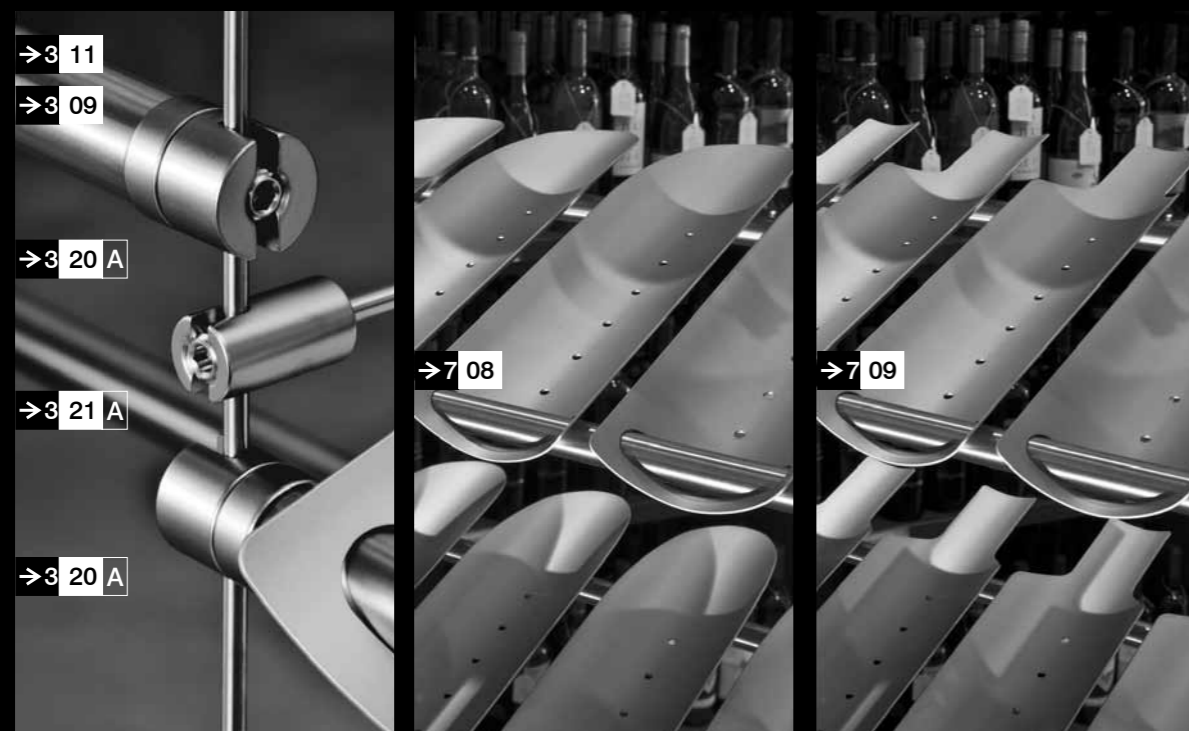
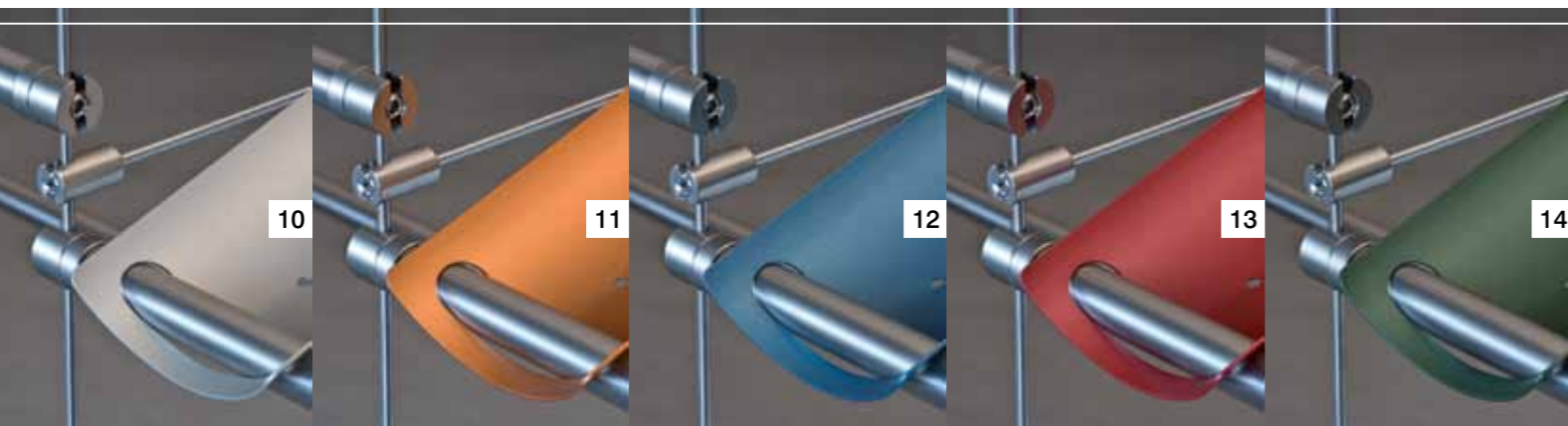

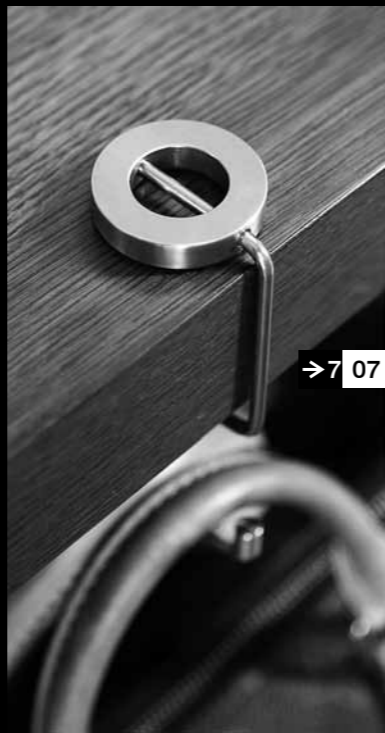

Un oggetto indispensabile per ogni occasione, ristorante, parrucchiere, ufficio, per non lasciare incustoditi gli oggetti più intimi e privati.

An essential object for every occasion, restaurant, hairstylist, office, not to let the most intimate and private objects unguarded.

Unentbehrlich für alle Gelegenheiten, im Restaurant, beim Friseur, im Büro, um persönliche Gegenstände nicht unbeaufsichtigt zu lassen.

Un objet indispensable en toutes occasions - restaurant, coiffeur, bureau - pour ne pas laisser sans surveillance les objets les plus intimes et personnels.

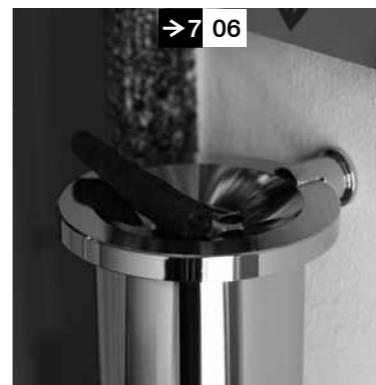

Ovunque la cortesia ricerchi essenzialità ed eleganza.
Wherever courtesy goes with essentiality and elegance.
Überall dort, wo Wesentlichkeit und Eleganz gefragt sind.
Là où la courtoisie recherche essentialité et élégance.



Casa, negozio, cabina armadio, showroom, atelier, franchising.
Home, store, closet, showroom, atelier, franchising.
Haus, Geschäft, begehbare Kleiderschrank, Showroom, Atelier, Franchising.
Maison, magasin, cabine-armoire, salle d'exposition, atelier, franchisage.

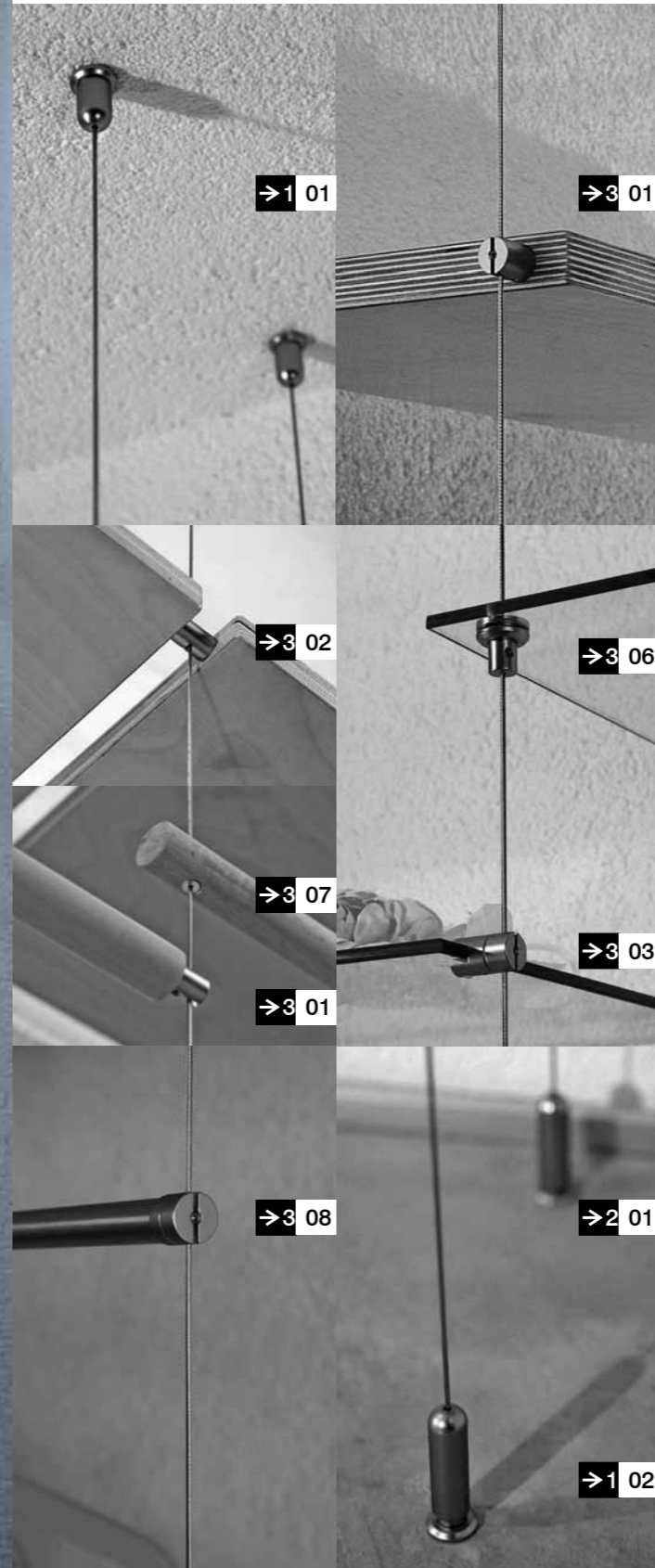



Esporre, ordinare e organizzare lo spazio con la massima funzionalità, estrema semplicità e il minimo impatto strutturale.

Showcasing, ordering and organizing space with maximum functionality, extreme simplicity and minimal structural impact.

Ausstellen, aufräumen und mit maximaler Funktionalität, Einfachheit und geringer Struktur Räumlichkeiten organisieren.

Exposer, agencer et organiser l'espace pour une fonctionnalité majeure, une simplicité extrême et un moindre impact structural.

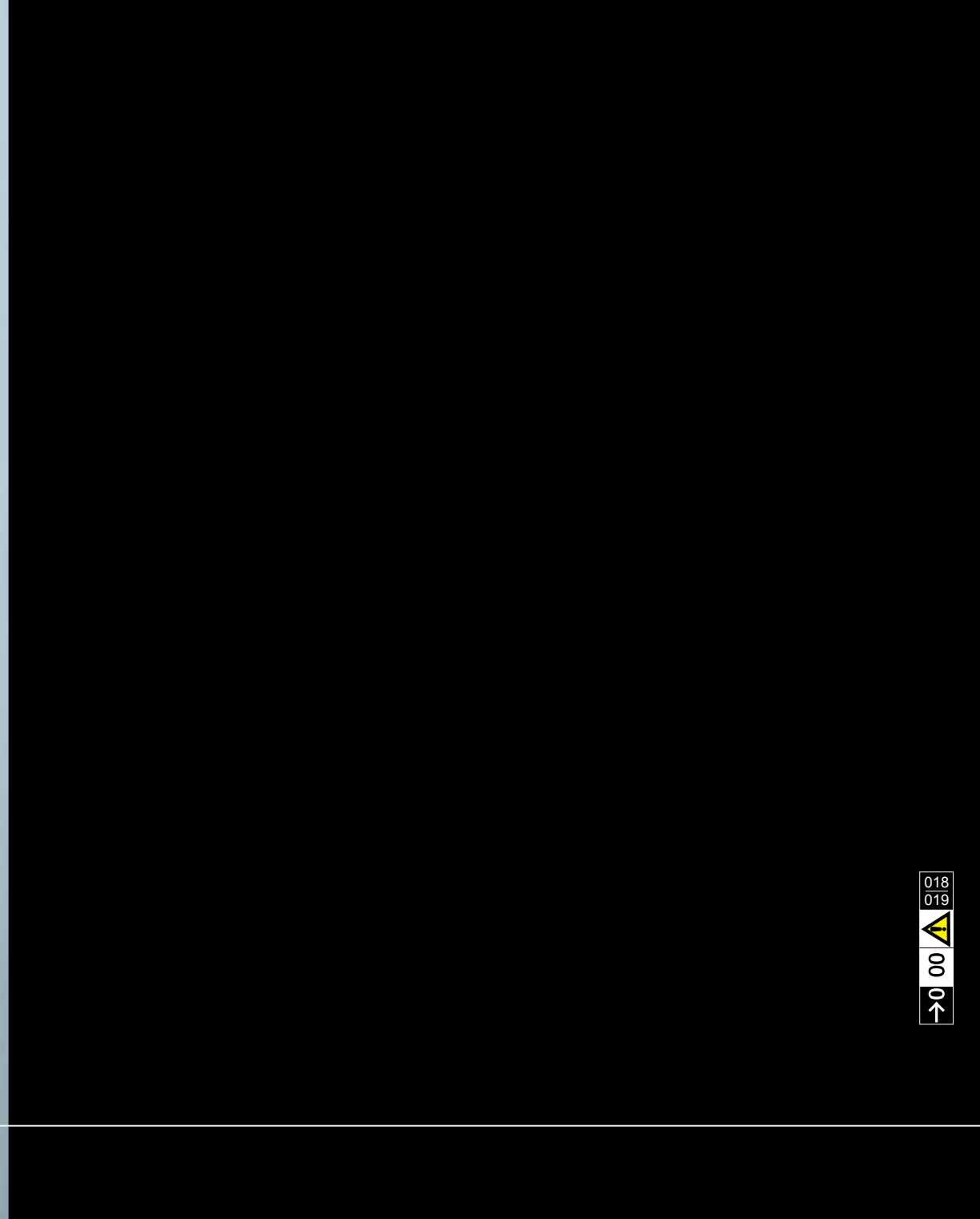



Adattare ogni volta lo spazio alle esigenze quotidiane diviene un gioco che usa il sistema magnetico per il rapido fissaggio degli elementi.

Adapting the space to daily necessities is like a game using the magnetical system with its easy fixing system.

Den Raum an die täglichen und wechselnden Anforderungen anpassen wird zu einem Spiel. Die Systeme werden schnell und einfach mit Magneten befestigt.

Adapter toutes les fois l'espace aux exigences quotidiennes devient un jeu qui utilise le système magnétique pour un assemblage rapide des éléments.

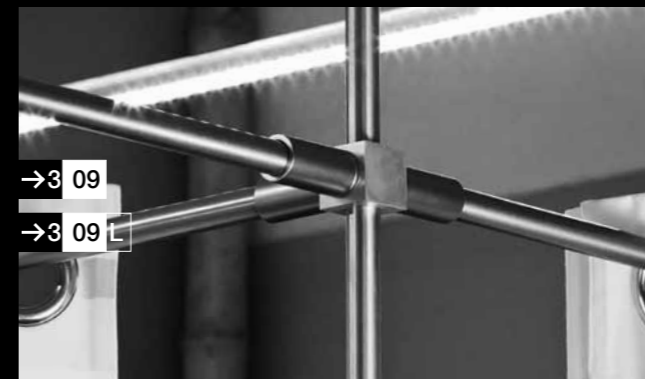

Dividere in modo elegante, semplice e funzionale è la vocazione del sistema a tubo che si adatta ad ogni spazio intervenendo con minimo ingombro e grande solidità.

Dividing in an elegant, simple and functional way : our tube system fits any space, it's robust and designed to take up as little space as possible.

Elegante, einfache und funktionelle Raumteilung mit dem Rohrsystem, das an alle Räume angepasst werden kann. Es benötigt nur wenig Platz und ist sehr stabil.

Diviser d'une façon élégante, simple et fonctionnelle : notre système à tube s'adapte à chaque espace, en occupant peu de place, tout en étant robuste.

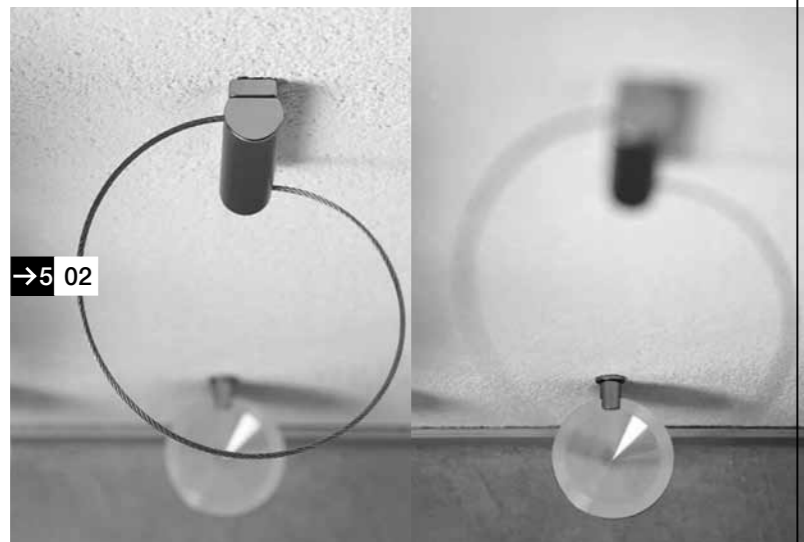

Casa, negozio, ufficio: ovunque la presenza richieda servizio.
Home, store, office: anywhere a service is requested.
Haus, Geschäft, Büro: überall dort, wo Service notwendig ist.
Maison, magasin, bureau: là où la présence est synonyme de service.



024
025
00
↑



026
027
00
→

Identificare spazi sociali, ricreativi, culturali e di servizio modificando le destinazioni rapidamente, con semplicità.

Identification signs to identify social, recreation, cultural and service facilities, quick and easy to install and change.

Zeichen zur Identifizierung von gemeinnützigen, kulturellen, Dienst- und Freizeiteinrichtungen, die einfach und schnell montiert und ausgetauscht werden können.

Signaux d'identification des espaces sociaux, récréatifs, culturels et de service, faciles et rapides à installer et en modifier leur destination.



→4 01



→4 08



→4 07



→4 03



→4 02 G



→10 03

028
029
00
→



→3 10 A

→4 10

→3 12 F

→3 11

→3 10 C

→3 16 C

→10 02

→3 12 D



→10 03 B



→10 03 B



030
031
→0 00
→

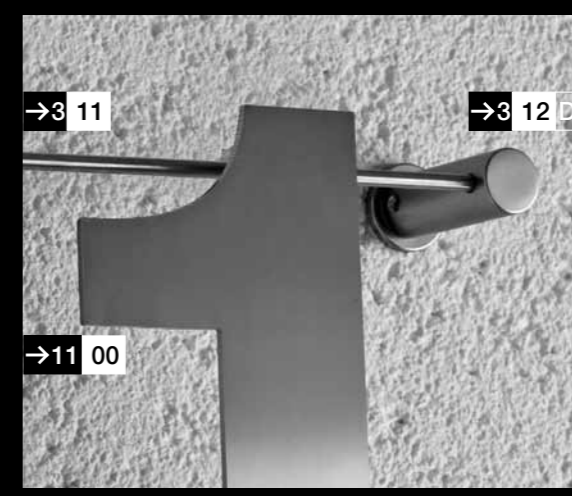

→3 11

→3 12 D

→11 00

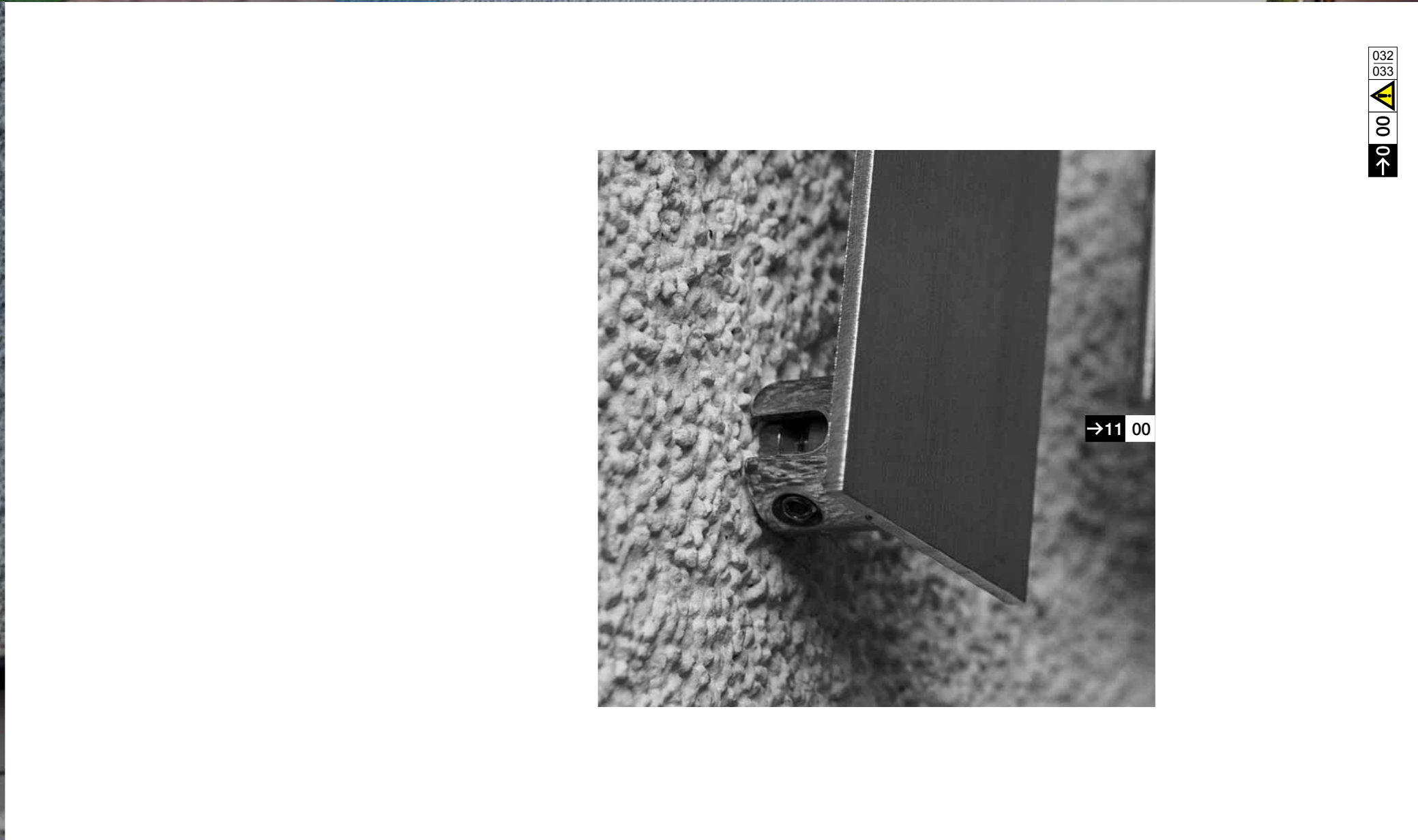

 MGB GT
1967



 MGB GT
1967

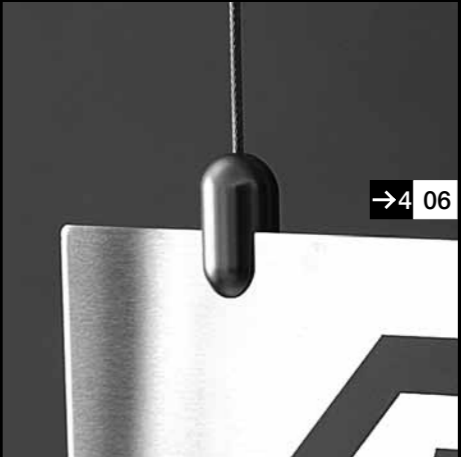

034
035
00
↑

→4 06



Casa, ufficio: arredare, arricchire lo spazio di funzioni, valorizzare l'ambiente con particolari ricercati e preziosi.

Home, office: furnishing, enriching space with new functions, valorizing the ambient with precious details.

Haus, Büro: einrichten, den Raum mit Funktionen ausstatten und mit ausgesuchten und wertvollen Elementen aufwerten.

Maison, bureau : agencer, enrichir l'espace de fonctions, valoriser le milieu de détails recherchés et précieux.

Casa, ufficio, negozio: sostenere, esporre, valorizzare e arredare le pareti.

Home, office, store: sustaining, exhibiting, valorizing and furnishing walls.

Haus, Büro, Geschäft: stützen, ausstellen, Wände aufwerten und ausstatten.

Maison, bureau, magasin: soutenir, exposer, valoriser et équiper les murs.

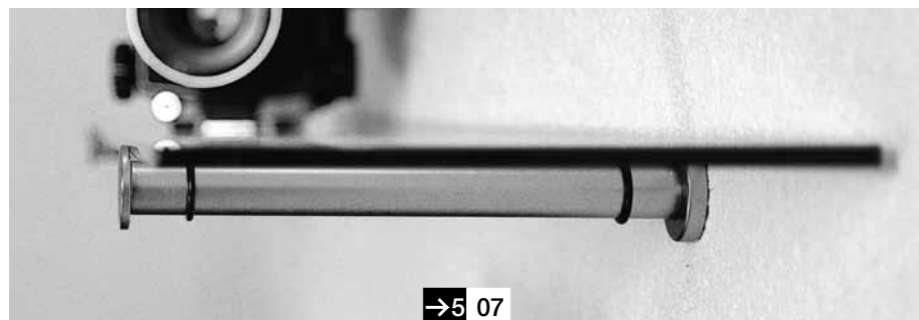

Il riparo, la privacy e il decoro, divengono momenti di semplicità e di estrema eleganza con il sistema Tahuma.

Privacy and decoration become simple and extremely elegant with the Tahuma system.

Privatsphäre und Dekoration werden mit Tahuma Systemen zu einfachen Momenten extremer Eleganz.

Protection, confidentialité et décoration deviennent des moments de simplicité et d'extrême élégance avec le système Tahuma.

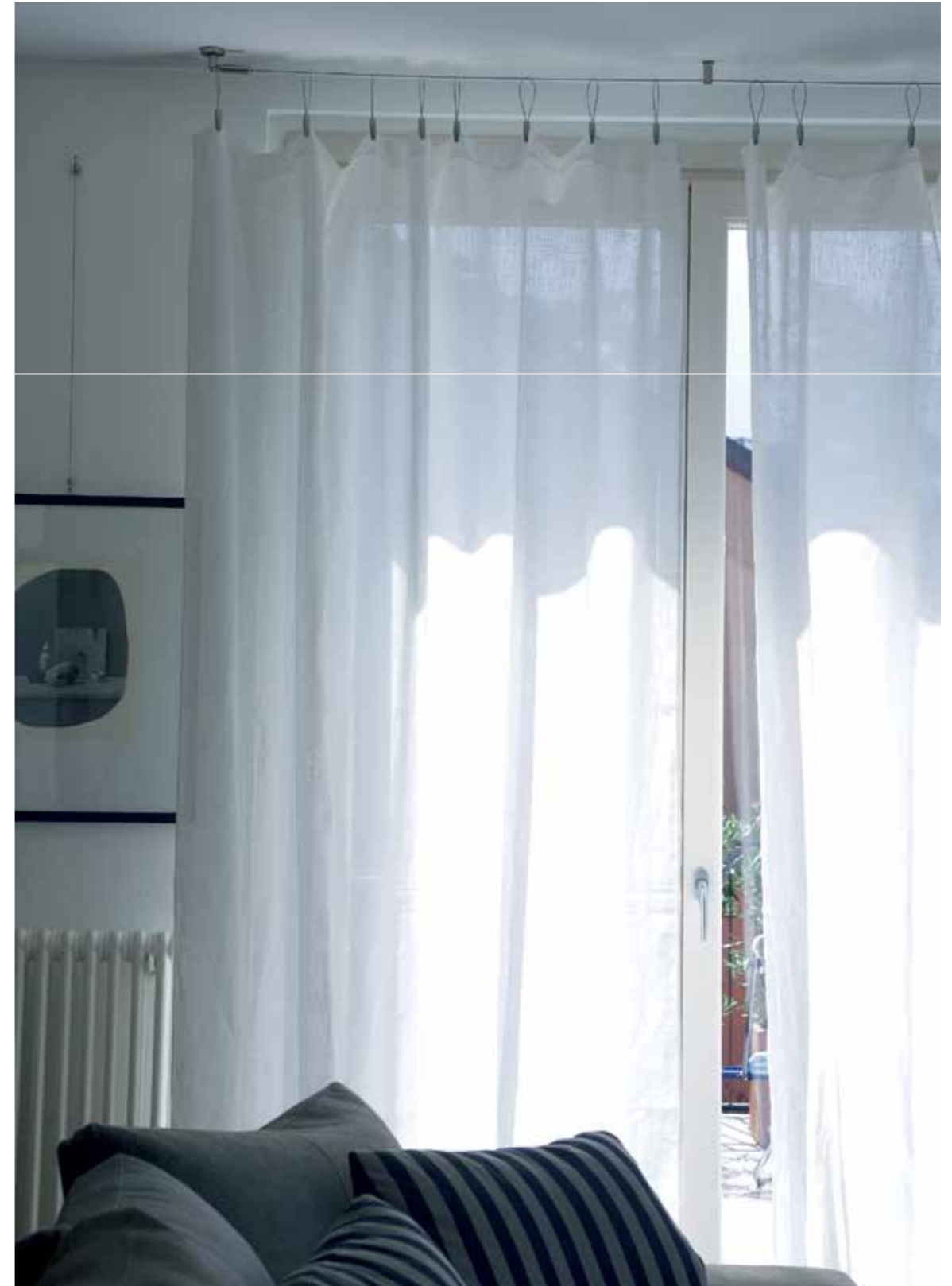
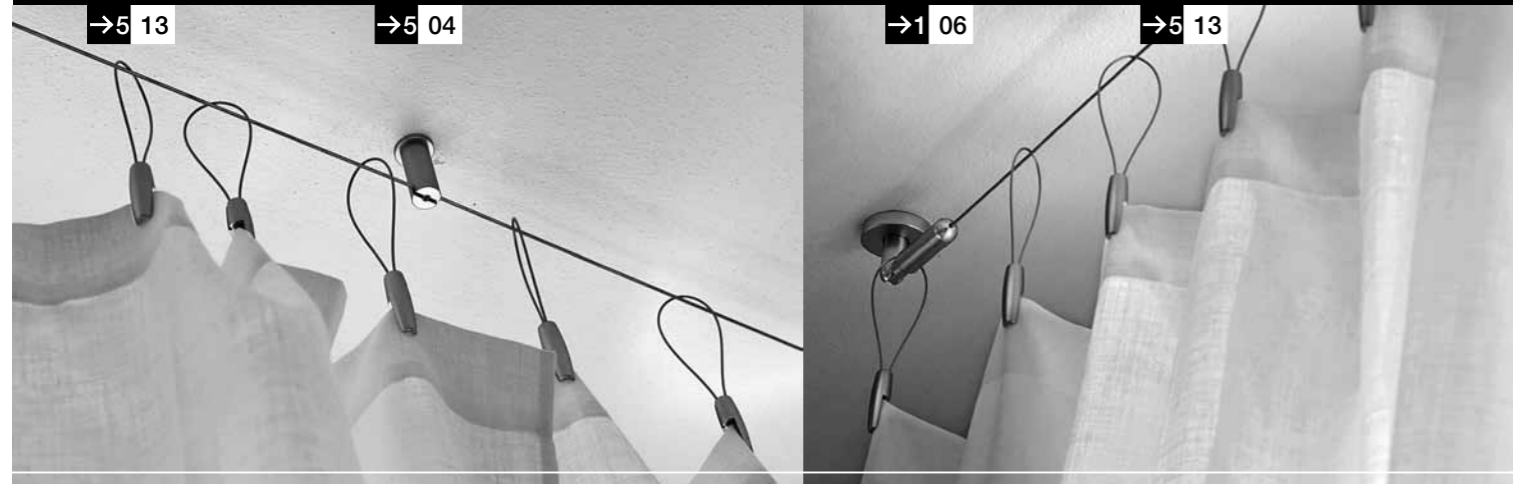



→3 09

→3 09 G

Due sistemi: a tubo e a barra; due soluzioni per la privacy e la decorazione d'interni con eleganza ed estrema praticità.

Two systems: tube and bar type; two solutions for setting up elegant and very practical spaces.

Zwei Systeme: mit Rohr und mit Stab; zwei Lösungen, um Innenräume elegant und praktisch einzurichten.

Deux systèmes: à tube et à barre, deux solutions pour décorer vos espaces d'une façon élégante est très pratique.

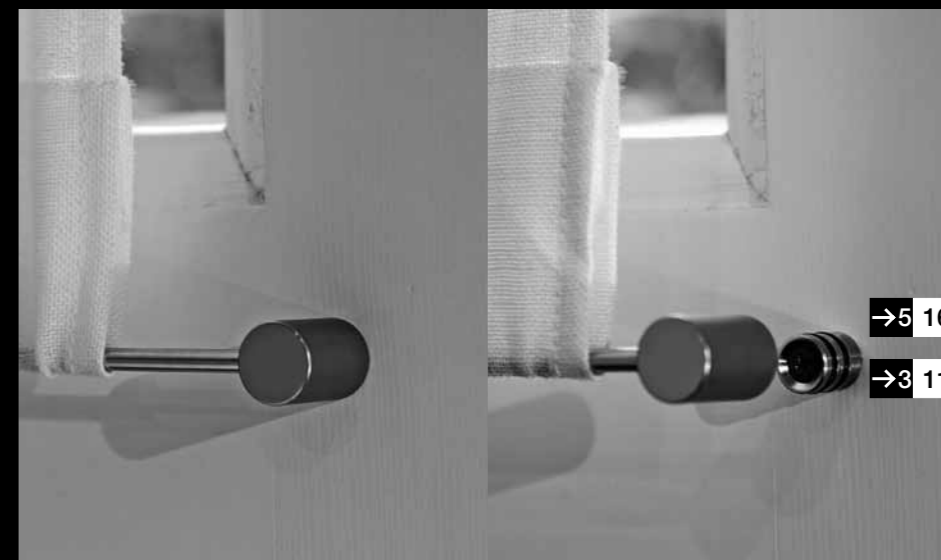

→5 16

→3 11

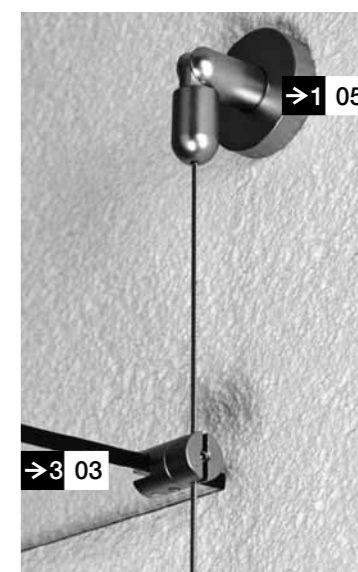
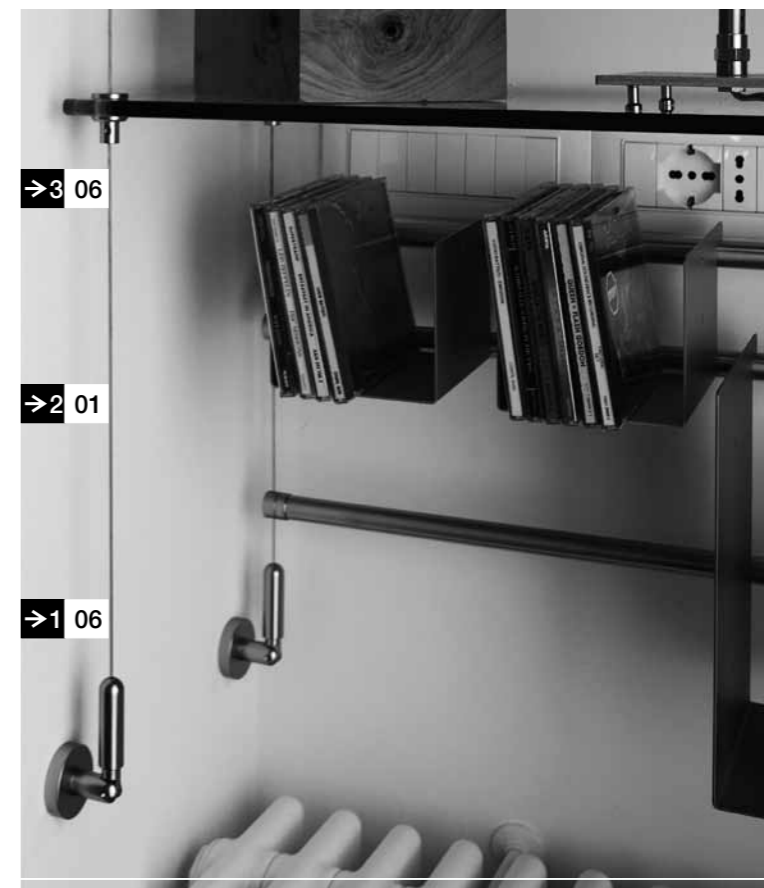

Casa, ufficio, negozio: mettere in evidenza tutto ciò che piace.
 Home, office, store: highlighting all objects of preference.
 Haus, Büro, Geschäft: alles was gefällt hervorheben.
 Maison, bureau, magasin: montrer tout ce qui plaît.



→ 2 01

→ 3 11

→ 3 21 B

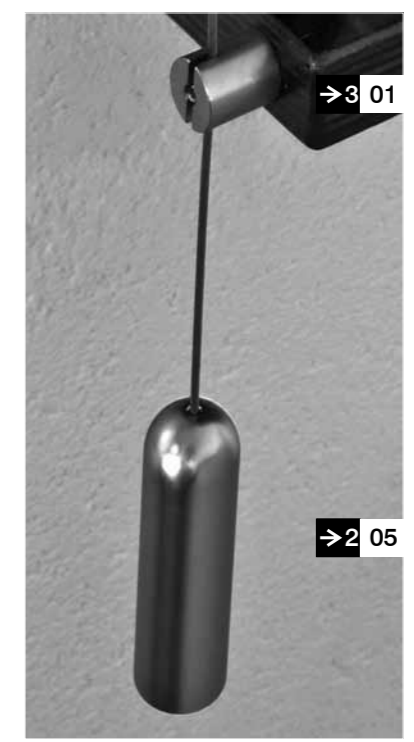

→ 3 01

→ 2 05

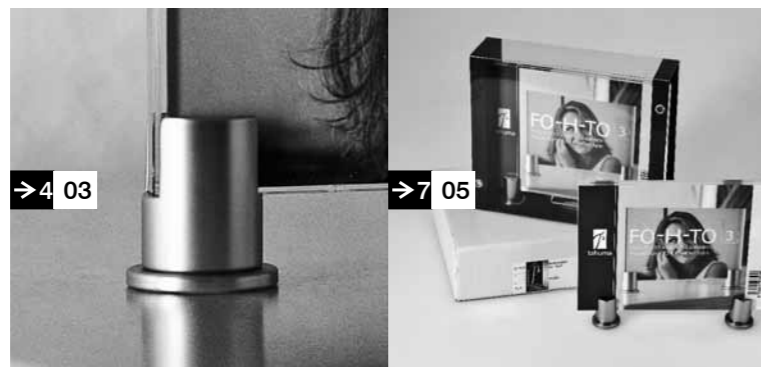

Particolari universali che completano l'ambiente del vissuto quotidiano.
Universal details that complete daily life.
Universelle Teile, die den täglichen Wohnraum ergänzen.
Des détails universels qui complètent la pièce du vécu quotidien.



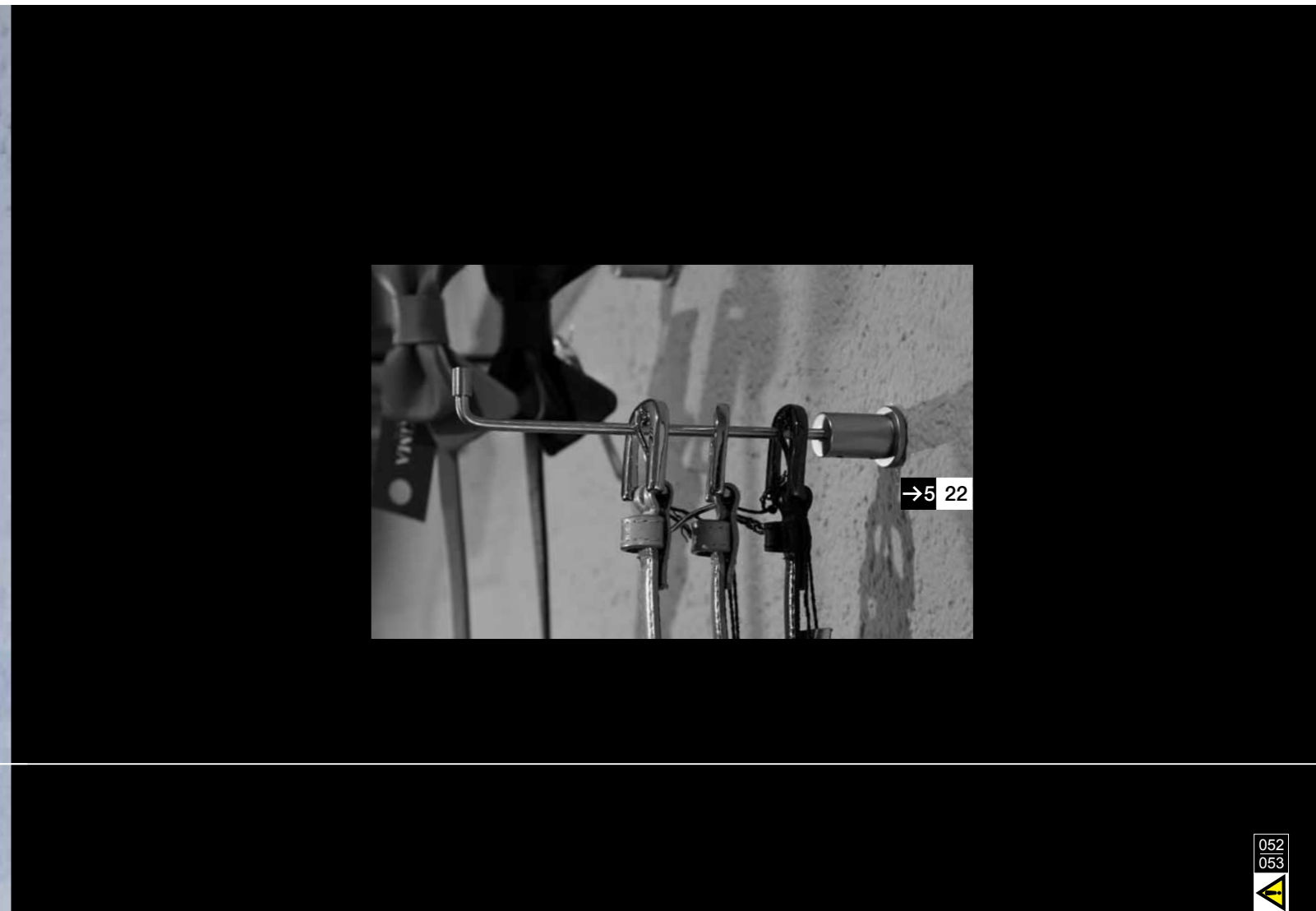

Oggetti di estrema necessità divengono occasioni di eleganza.

Basic objects with a touch of style.

Äußerst notwendige Dinge werden zu eleganten Elementen.

Des objets simplement nécessaires deviennent des occasions d'élégance.

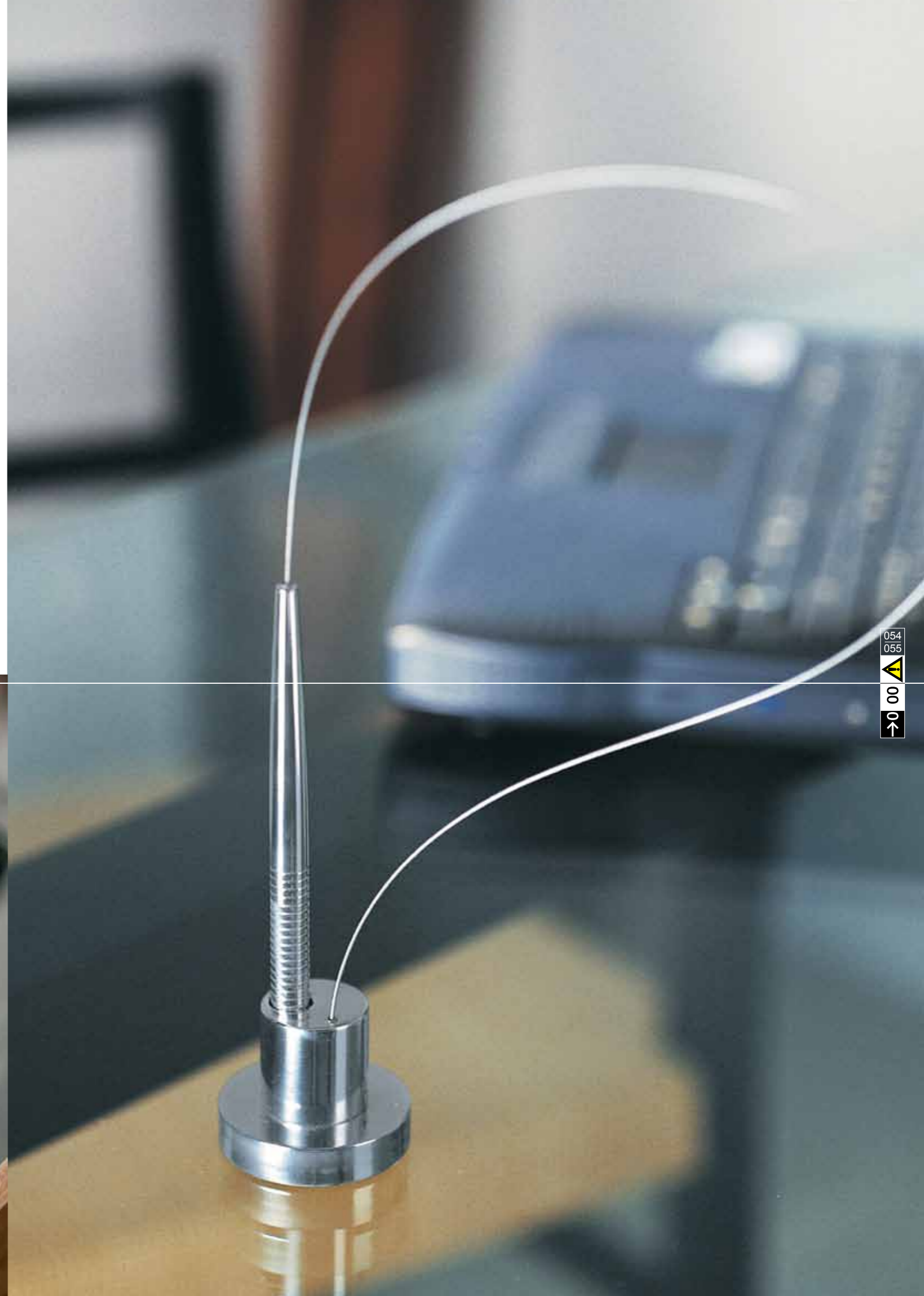

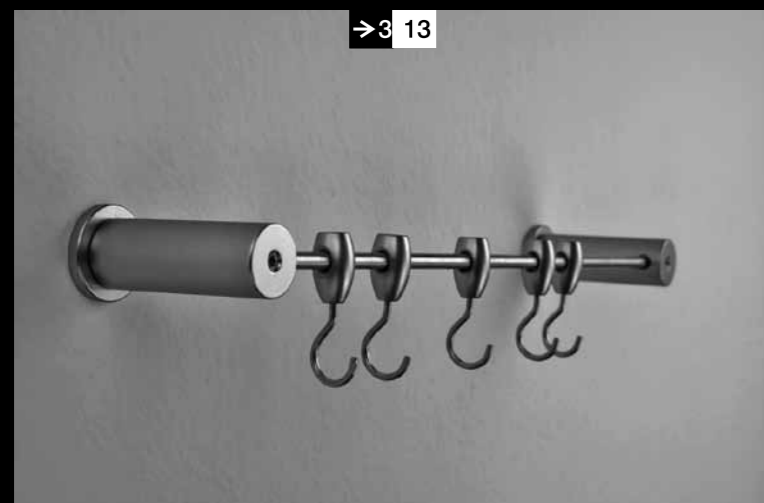

Un complemento indispensabile per piccole funzioni quotidiane.

An helpful object for daily needs.

Eine unentbehrliche Ergänzung für kleine tägliche Tätigkeiten.

Un complément indispensable pour de simples fonctions quotidiennes.

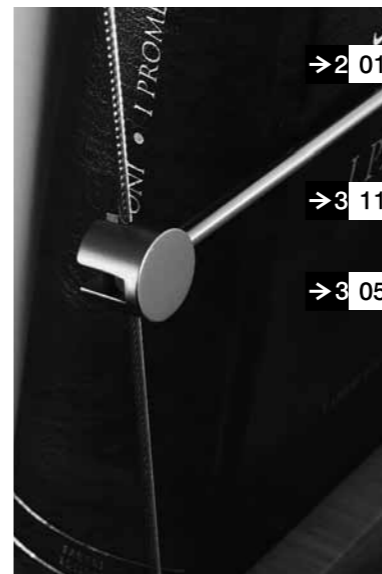
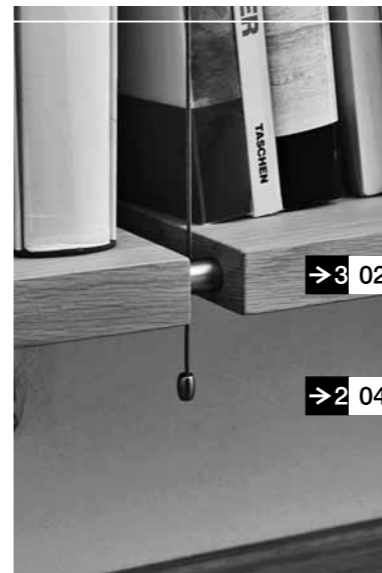

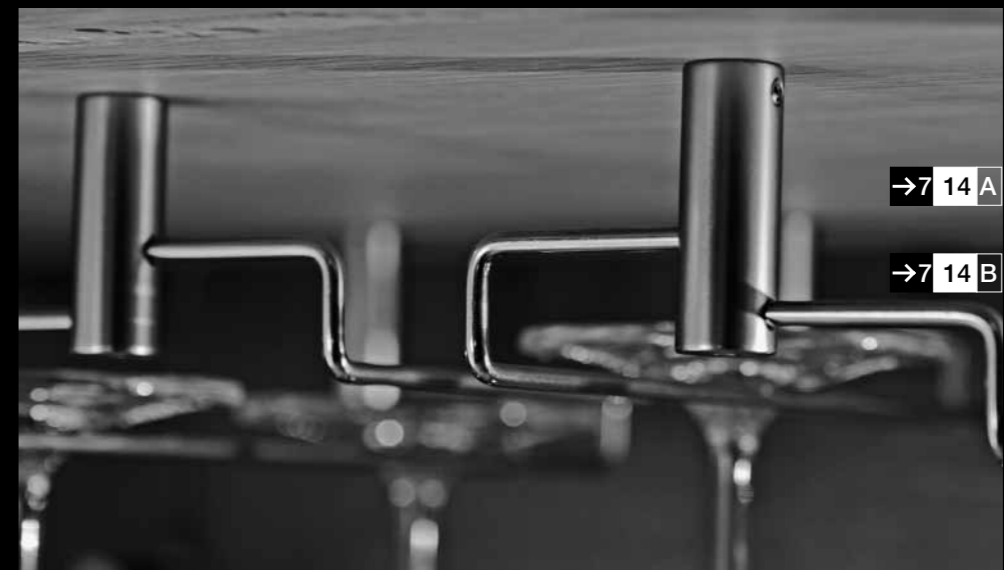
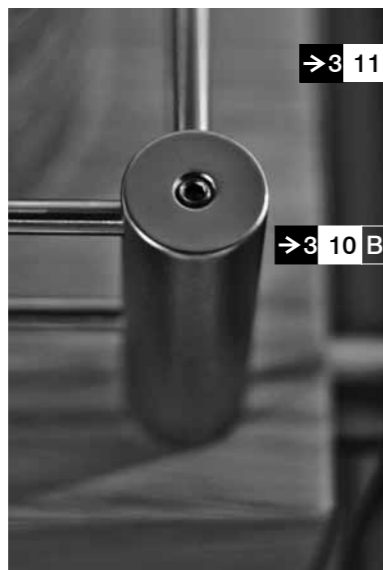
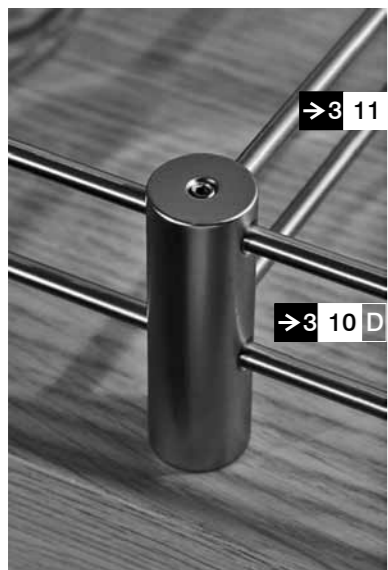

→7 14 B



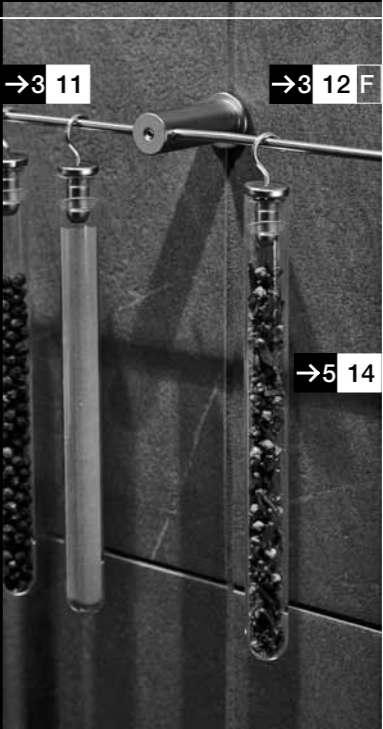
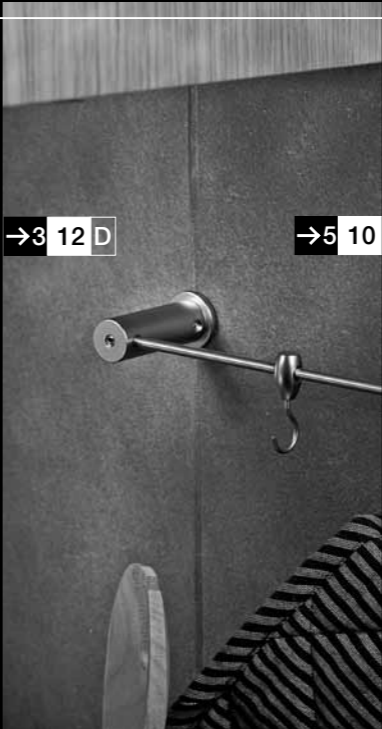



066
067
00
00

Il bagno è un luogo speciale, ogni elemento deve essere utile con discreta ed essenziale presenza, senza invadere lo spazio dedicato al relax e alla bellezza.

Bathroom is a special place, where every element must be useful with discreet and essential presence, without invading the space dedicated to relax and beauty.

Das Badezimmer ist ein besonderer Ort. Alle Elemente müssen nützlich sein und diskret zur Verfügung stehen, ohne Platz für Relax und Schönheit einzunehmen.

La salle de bains est un lieu spécial, chaque élément doit être utile et avoir une présence discrète et essentielle, sans envahir l'espace consacré à la détente et à la beauté.

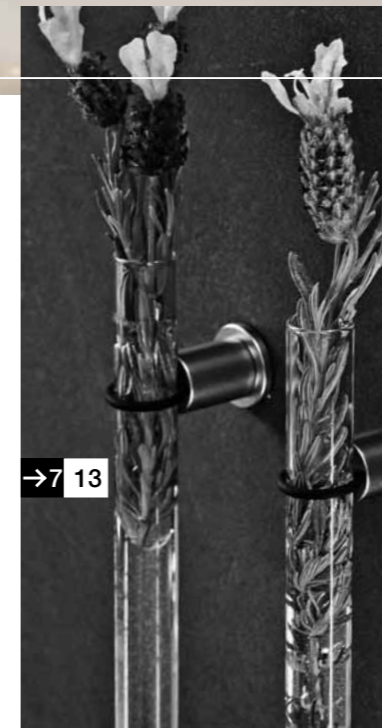

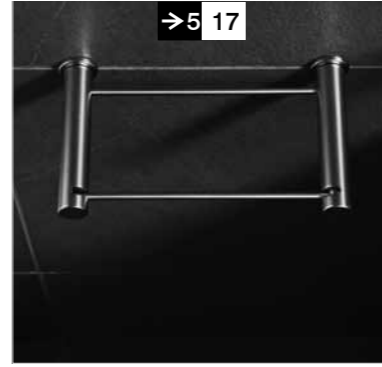
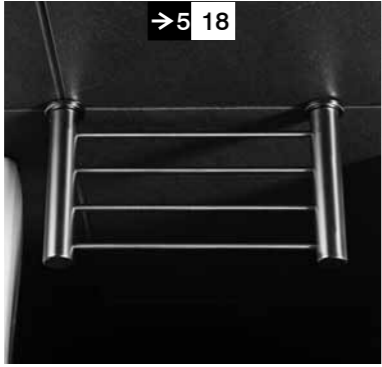

068
069
00
00

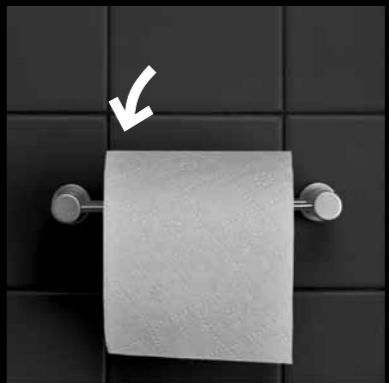
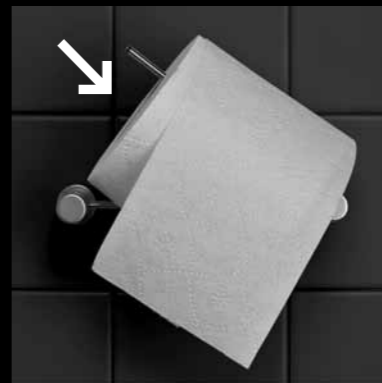
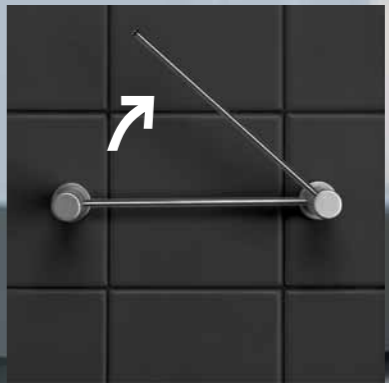
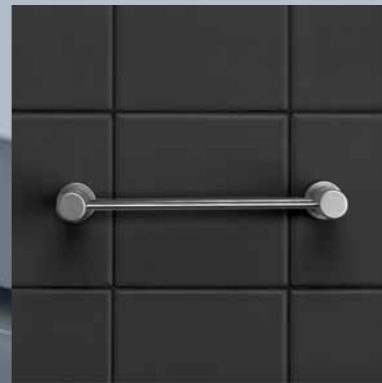

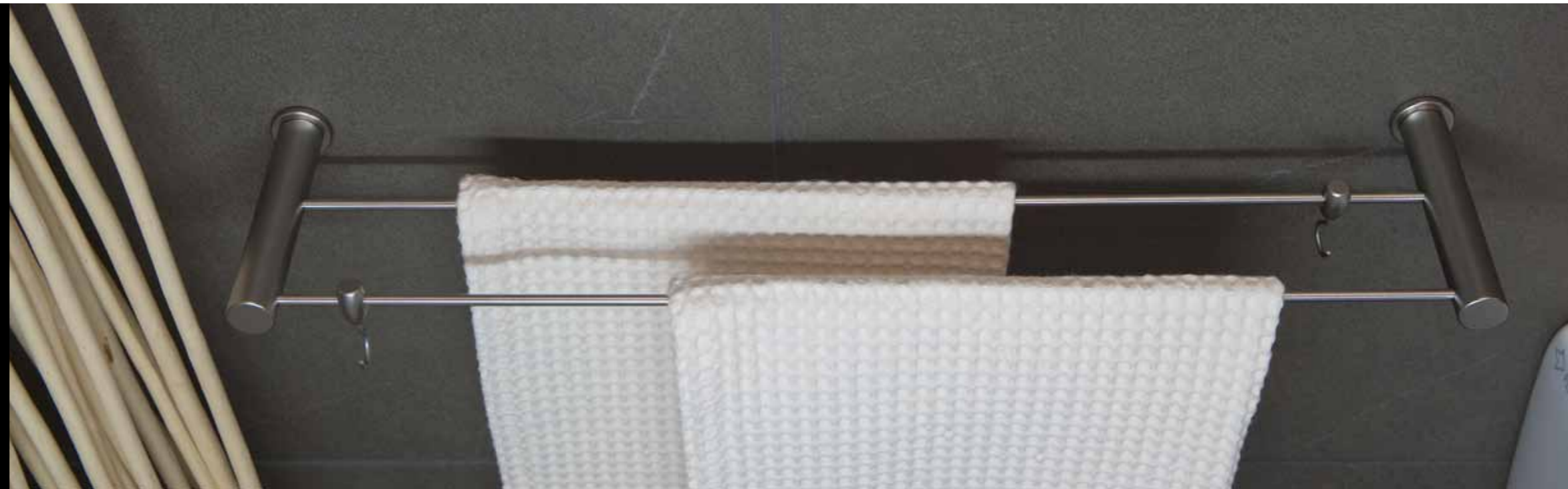
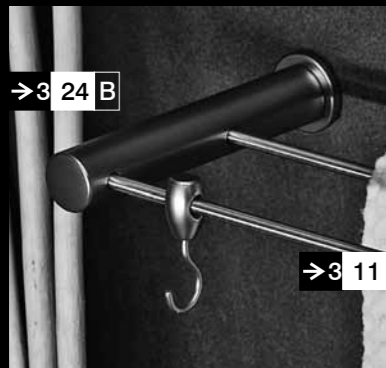
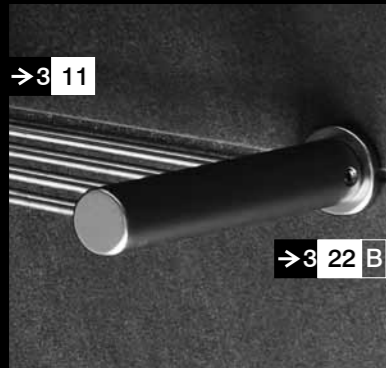
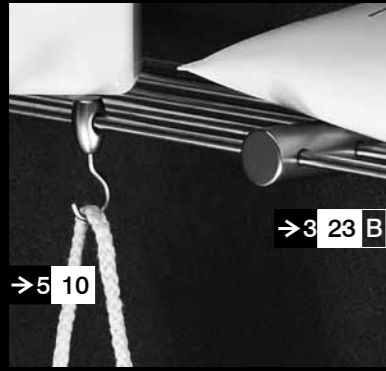



→5 03

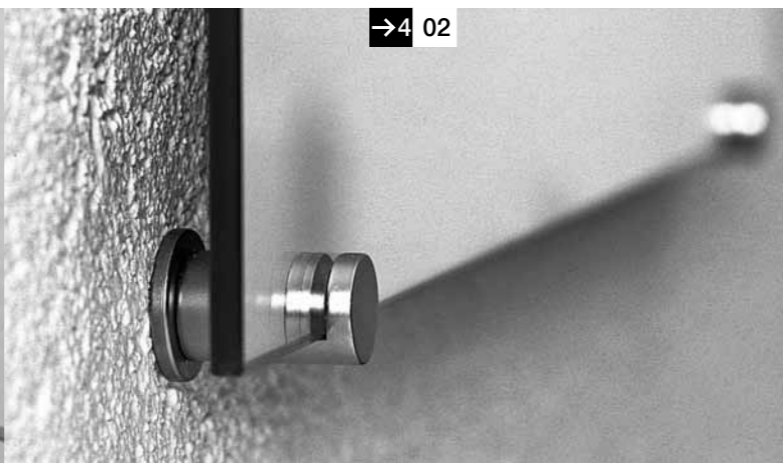

→4 02



→3 09

→3 09 C

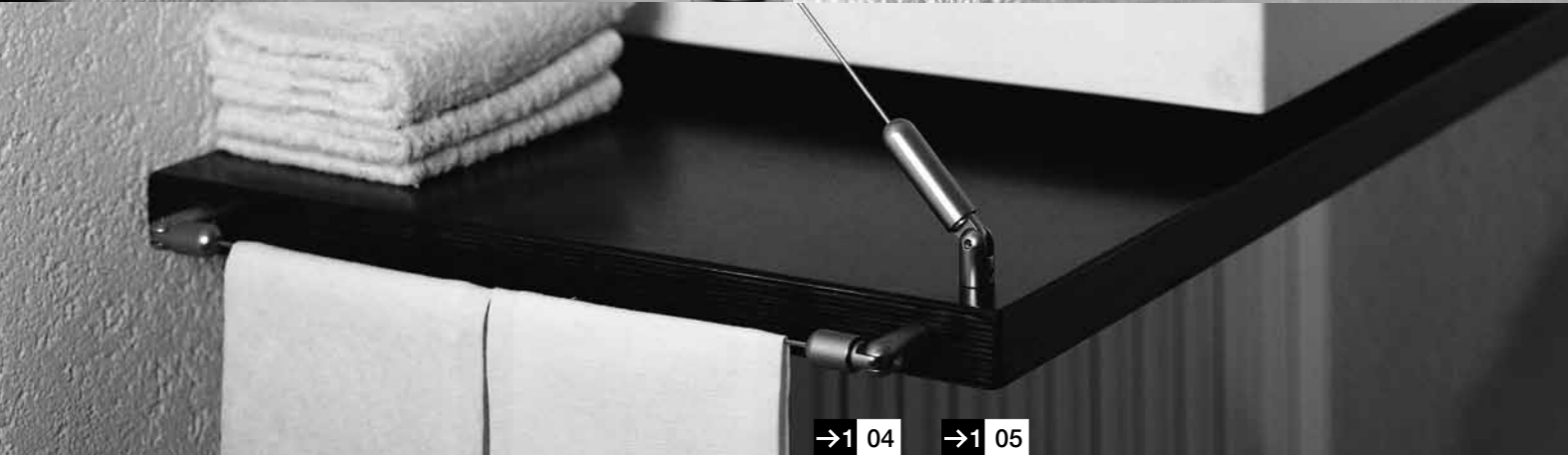

→1 04

→1 05

Ogni situazione può trasformarsi in un assieme di piccole, grandi necessità che si valorizzano come particolari di qualità estetica.

Every situation can become an ensemble of big and small necessities that valorize aesthetic details.

Jede Situation kann sich in ein Zusammenspiel von kleinen und großen Anforderungen verwandeln, die sich durch ihre Qualität hervorheben.

Chaque situation peut se transformer en un ensemble de petites et grandes nécessités mises en valeur comme des détails de qualité esthétique.



Utilizzare qualunque struttura nell'ambiente è l'occasione per moltiplicare le funzioni creando ulteriore comfort.

To make use of all structures in an environment becomes the occasion to increase the functions and to create further comfort.

Die Möglichkeit alle Strukturen im Raum zu verwenden, bietet Gelegenheit Funktionen zu vervielfältigen und zusätzlichen Komfort zu schaffen.

Utiliser une quelconque structure présente dans la pièce est l'occasion d'en multiplier les fonctions en créant davantage de confort.

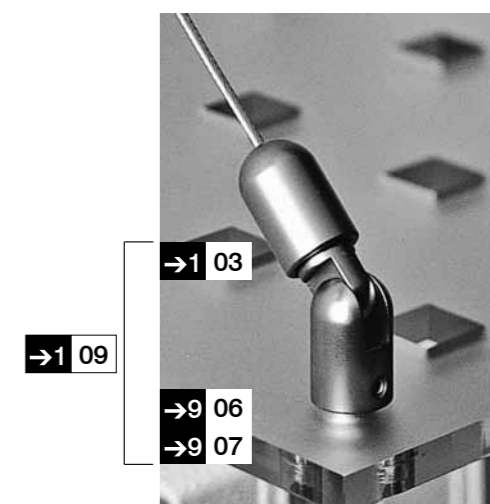
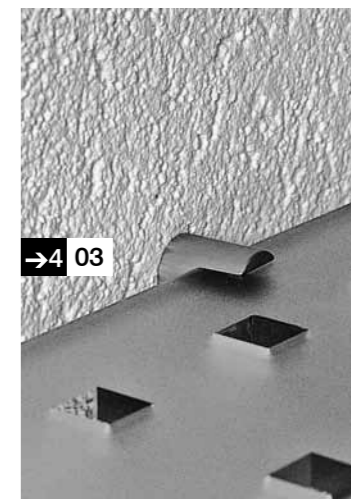
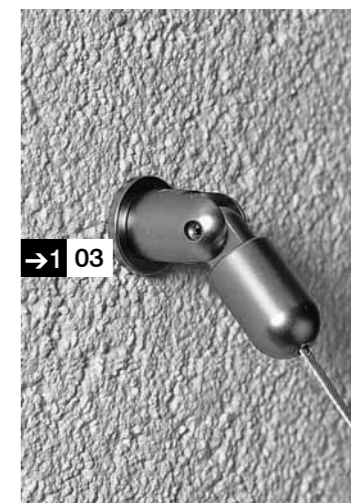



Tutti gli spazi domestici, professionali o espositivi divengono luoghi dedicati e riservati, grazie a soluzioni leggere ma decise, in grado di separare gli ambienti.

All spaces, domestic, professional or for exhibit become specialized and reserved parts, thanks to light but decisive solutions that can separate places.

Alle Räume im Haus, im Büro oder in Showrooms werden diskret, aber dennoch entschieden mit unseren Raumteilern abgetrennt.

Tous les espaces domestiques, professionnels ou d'exposition deviennent des lieux dédiés et réservés, grâce à des solutions légères mais précises, en mesure de séparer les espaces.

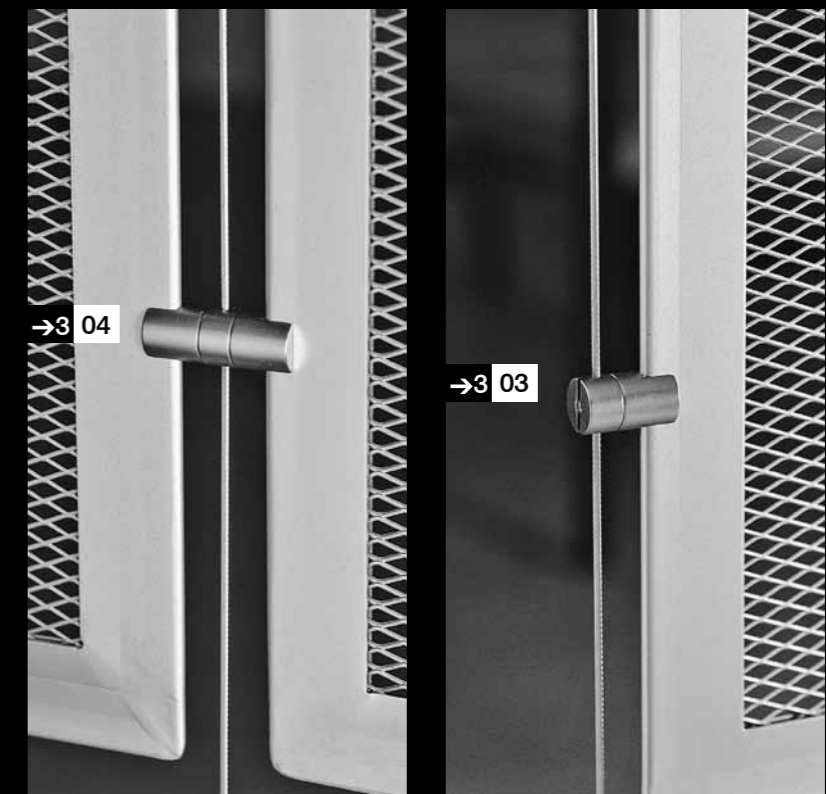

Creare spazi dedicati alle varie funzioni diviene un esercizio di stile.

Dedicated spaces designed with style.

Räume für die unterschiedlichen Funktionen schaffen wird zu einer Stilübung.

Créer des espaces affectés aux différentes fonctions devient un exercice de style.

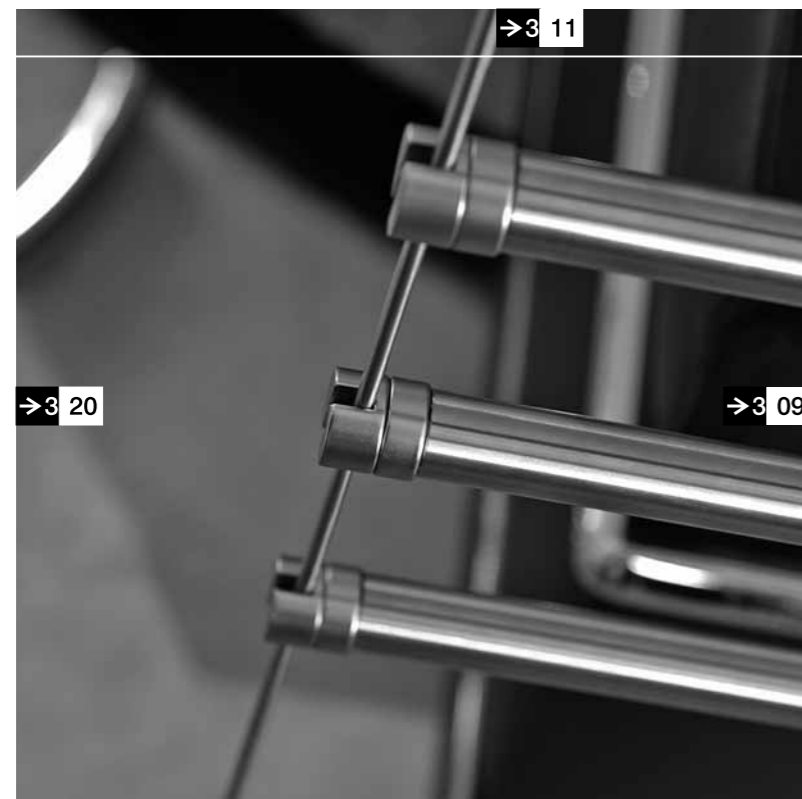



→ 1 02

→ 2 01

→ 3 09

→ 9 04



082
083
→ 00
←

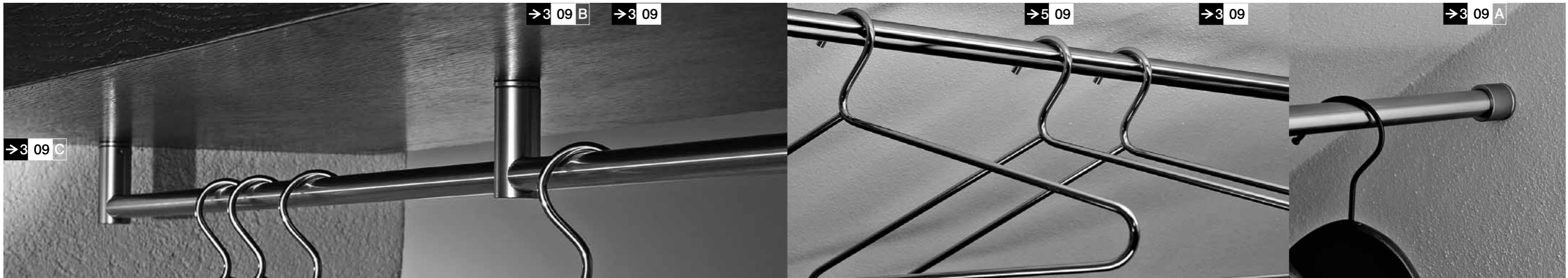

→ 3 09 C

→ 3 09 B → 3 09

→ 5 09 → 3 09

→ 3 09 A

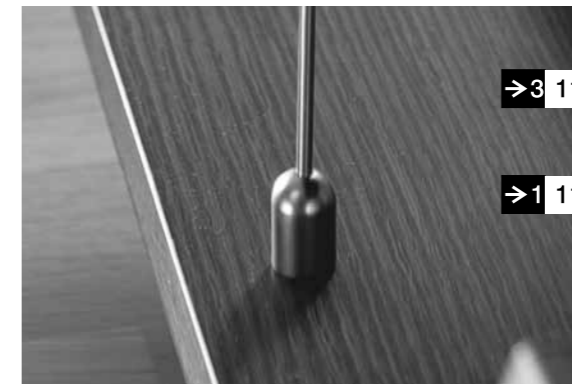

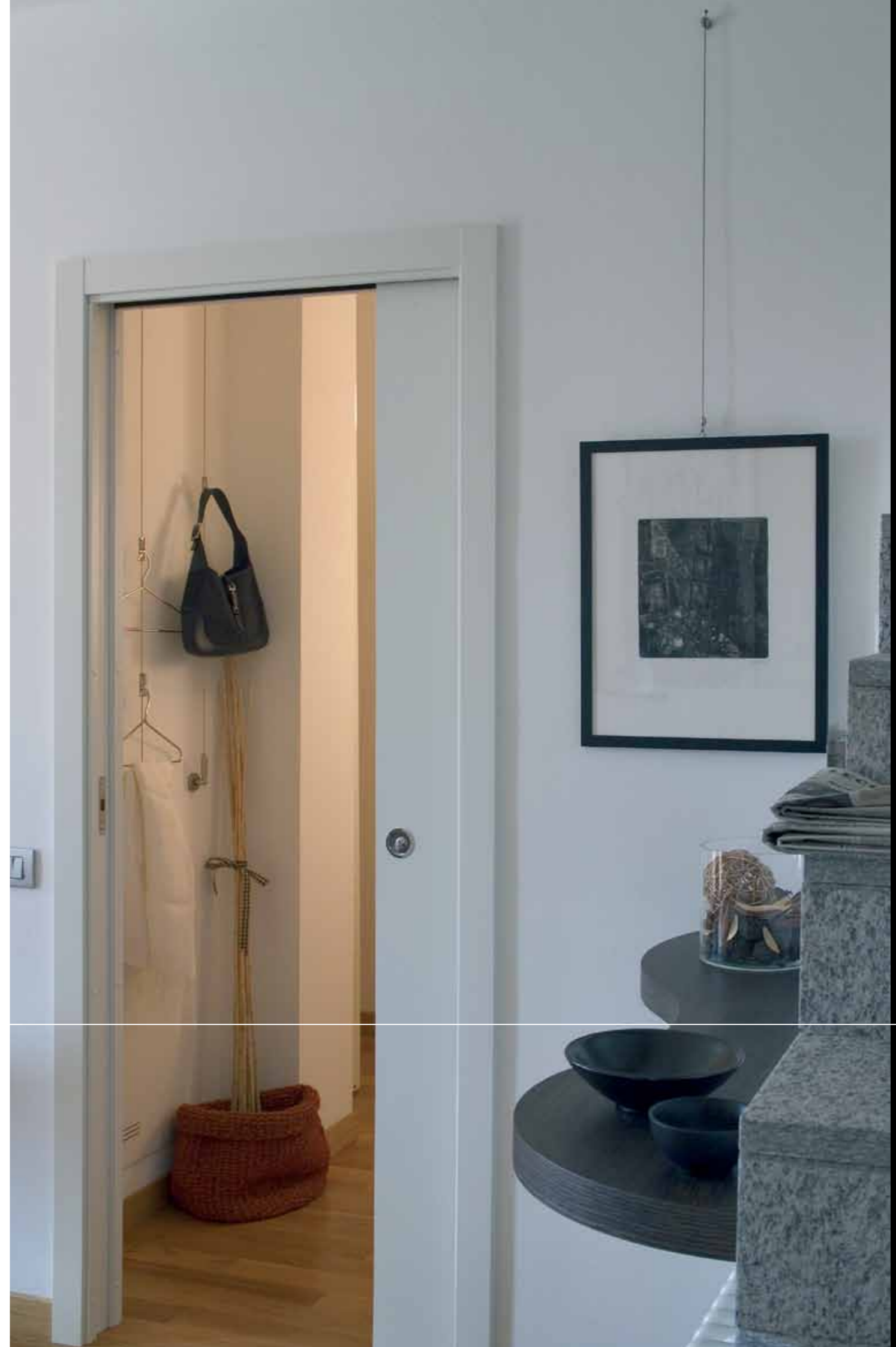
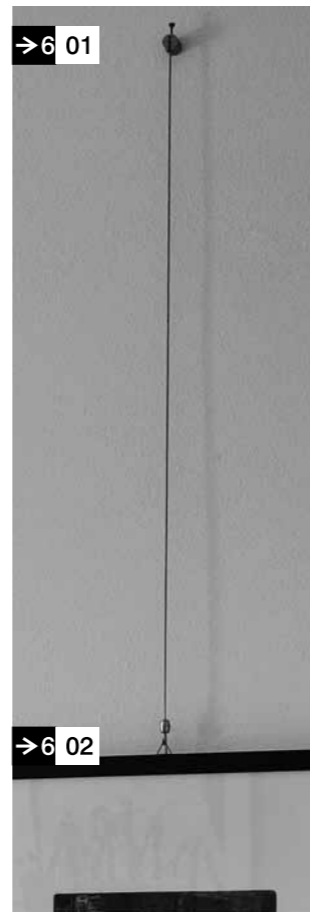
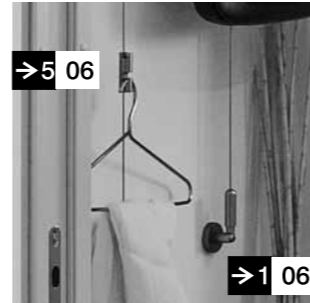
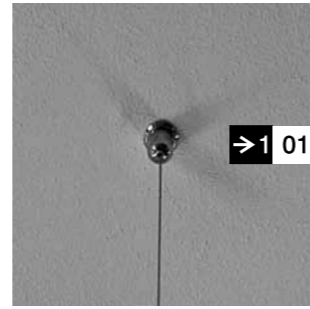

Ogni luogo è adatto ad ospitare il servizio che Tahuma interpreta con raffinato rigore.

Any place is good to use Tahuma, with its refined design.

Jeder Ort eignet sich dazu, den Service den Tahuma mit raffinierter Genauigkeit interpretiert zu beherbergen.

Chaque lieu est apte à accueillir le service que Tahuma interprète avec une rigueur raffinée.

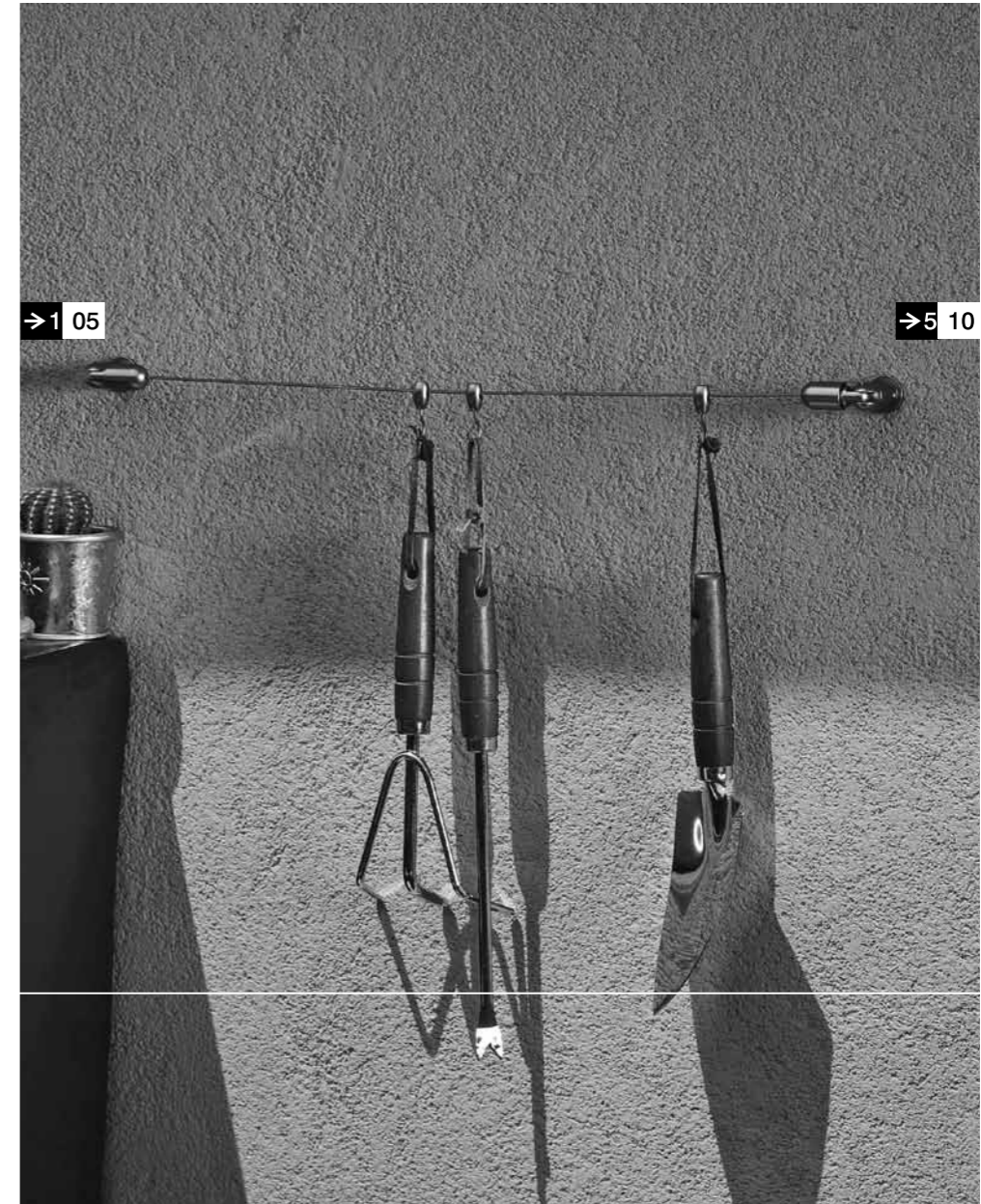
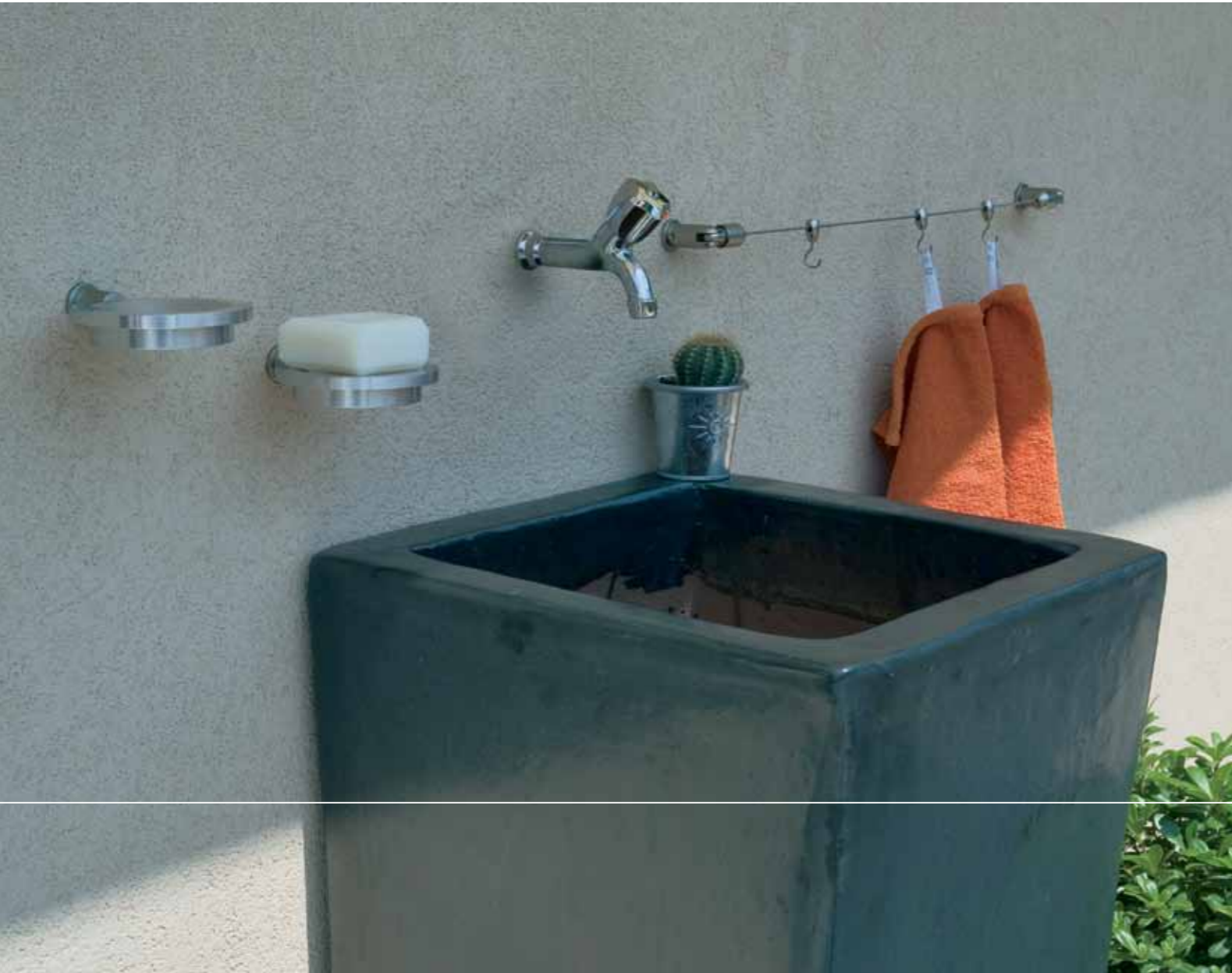

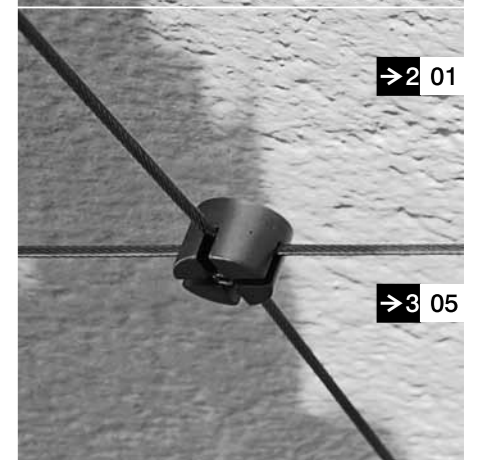
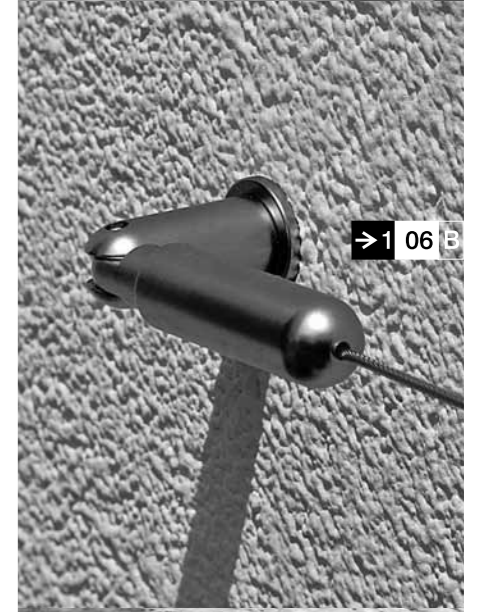
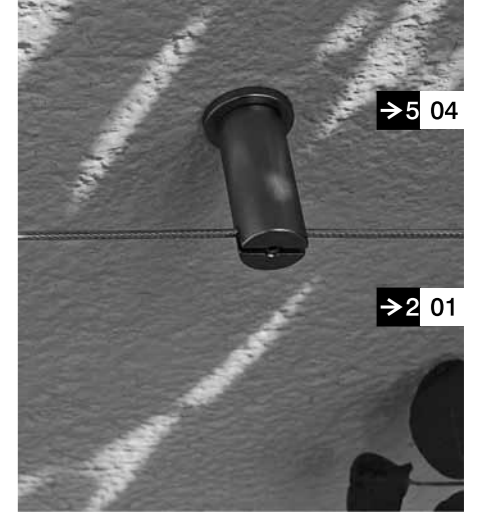

Decorare la facciata e guidare il verde: la funzione si eleva ad espressione estetica di qualità.

Decorating the facade and shaping the green for great aesthetic results.

Die Außenwand mit Kletterpflanzen dekorieren: Funktion verbunden mit Ästhetik und Qualität.

Décorer la façade et guider le vert: la fonction s'élève à une expression esthétique de qualité.

Alternative Interior Exposition

000
000



Numero di pagina del catalogo
Catalogue page number
Katalogseite
Numéro de page



Verificare le caratteristiche del prodotto e le condizioni di utilizzo sul manuale tecnico.
Check product information and using instructions on the technical handbook.
Produkteigenschaften und Gebrauchsbedingungen im technischen Handbuch prüfen.
Vérifier les caractéristiques du produit et ses conditions d'utilisation dans le manuel technique.



000
000
↑



Identificativo prodotto
Product reference mark
Produktidentifikation
Identification du produit

Tahuma ha progettato un sistema dinamico per appendere ed esporre alla parete e a soffitto senza vincoli.

Tahuma has designed a dynamic system for displaying on wall and on ceiling with no limits.

Tahuma hat ein dynamisches System entwickelt, um Dinge problemlos an die Wand und die Decke zu hängen und auszustellen.

Tahuma a conçu un système dynamique pour accrocher et exposer au mur et au plafond sans attaches.



Alternative Interior Exposition →

093



092

093



000

000



↑



094
095
00
↑

Una parete che non c'è è la nuova soluzione che Tahuma propone utilizzando il soffitto per separare gli ambienti e creare due pareti espositive.

A partition that doesn't exist is the solutions that Tahuma proposes using the ceiling to separate ambients and to create two expositive walls.

Eine Wand, die nicht existiert ist die neue Lösung von Tahuma, wobei die Decke verwendet wird, um die Räume zu teilen und zwei Ausstellwände zu schaffen.

Un mur qui n'est pas est la nouvelle solution que Tahuma propose en se servant du plafond pour séparer les pièces et créer deux parois d'exposition.

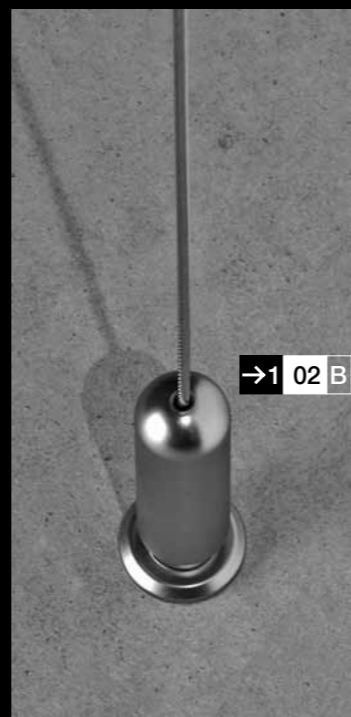

Nella versione mono o a doppio binario, Tahuma propone il rigore e l'essenza estetica di tutti i suoi prodotti aggiungendo funzione dinamica ovunque.

In the mono or double rail version, Tahuma gives the rigour and the aesthetic essence of all its products adding up dynamic function everywhere.

In den Ausführungen als Einfach- oder Doppelschiene bietet Tahuma bei allen Produkten Genauigkeit und ästhetische Essenz, wobei dynamische Funktion überall vorhanden ist.

Dans la version mono-rail ou double-rail, Tahuma propose la rigueur et l'essence esthétique de tous ses produits en ajoutant partout une fonction dynamique.

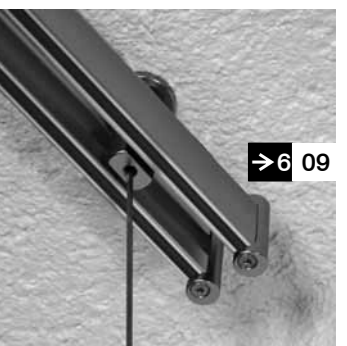
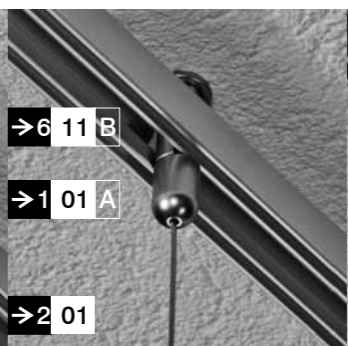
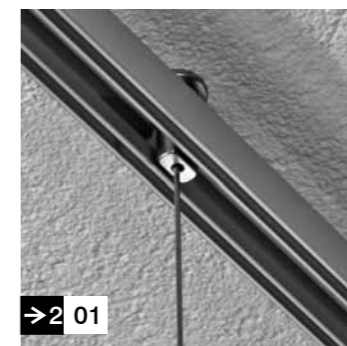
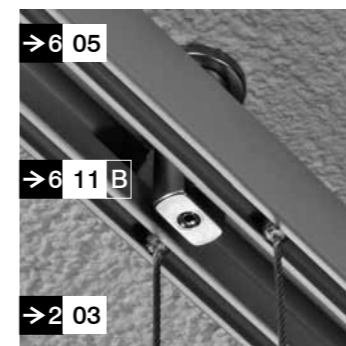
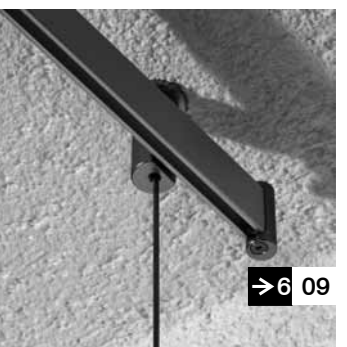
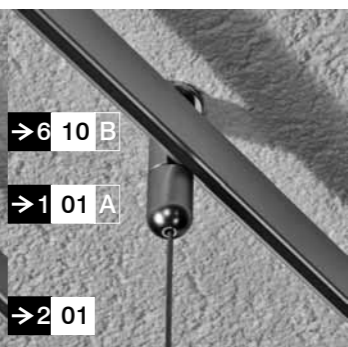
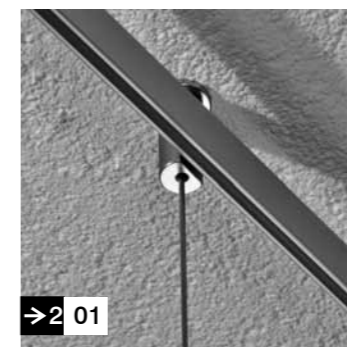
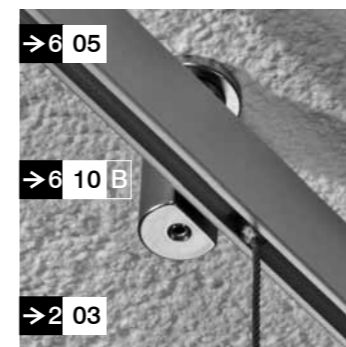



→ 4 02



In collezione o singolarmente, ogni espressione artistica trova con Tahuma l'esaltazione del mettersi in mostra con estrema sintesi.

Individually or in set, every artistic expression shows off itself at best with the extreme synthesis of Tahuma.

Zusammen oder einzeln, jeder künstlerische Ausdruck findet mit Tahuma die Möglichkeit sich mit Schlichtheit in Szene zu setzen.

En collection ou séparément, toute expression artistique trouve avec Tahuma l'exaltation de se montrer de façon extrêmement synthétique.



I diversi ambienti divengono un continuo armonioso che coordina tutti gli stili artistici.

All artistic styles in different ambients are co-ordinated with harmony.

Die unterschiedlichen Räume werden harmonisch miteinander verbunden, wobei alle künstlerischen Stile koordiniert werden.

Les différentes pièces deviennent une continuité harmonieuse qui coordonne tous les styles artistiques.

Disporre con cura i soggetti artistici con Tahuma diventa un arte che esalta e valorizza l'ambiente.

Arranging with care different artistic subjects it's easy: Tahuma it's the right way to exalt and emphasize the ambient.

Die Anordnung der künstlerischen Gegenstände von Tahuma wird zu einer Kunst, die den Raum verschönert und aufwertet.

Disposer avec soin les sujets artistiques devient avec Tahuma un art qui exalte et valorise l'espace.

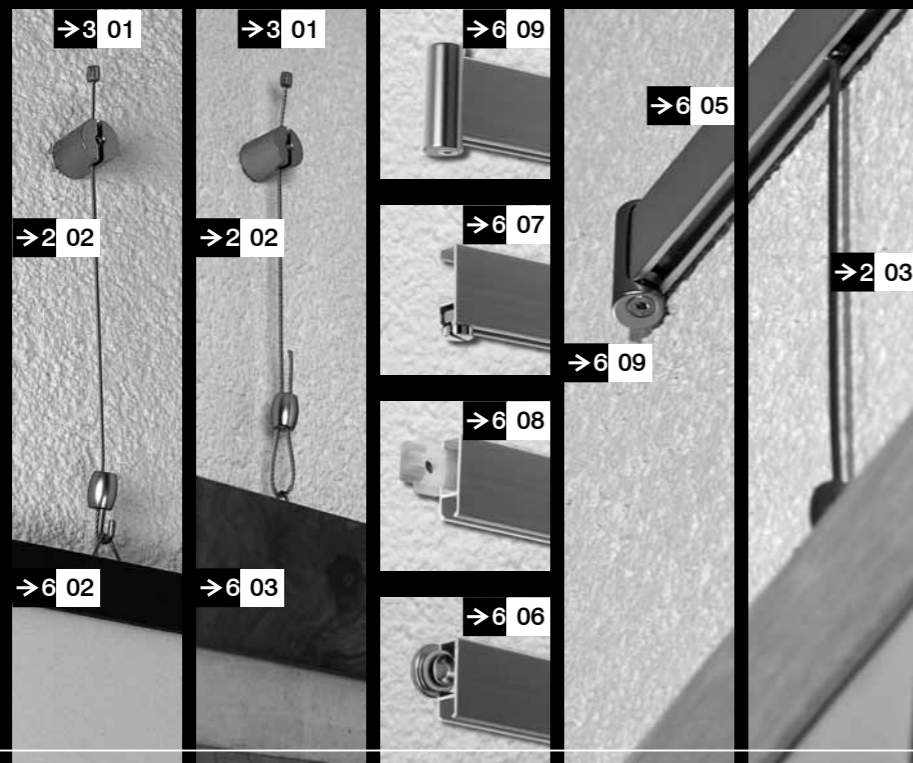

Alternative Interior Lighting

Alternative Interior Lighting è la nuova proposta di Tahuma derivata dall'interpretazione di oggetti di recupero industriale, trasformati, con innovative tecnologie d'illuminazione, in oggetti di riciclaggio fascino e curiosa ricchezza di personalità.

Alternative Interior Lighting is the new proposal of Tahuma resulting from the interpretation of recycling industrial objects which, through state of the art lighting technologies, are changed into refined and individually designed objects.

Das Alternative Interior Lighting ist der neue Vorschlag von Tahuma, der industrielle Recyclingprodukte neu interpretiert und sie mit innovativen Beleuchtungstechnologien in Objekte mit ausgesuchtem und individuellem Design verwandelt.

Alternative Interior Lighting est la nouvelle proposition de Tahuma dérivée de l'interprétation d'objets industriels recyclés, qui, grâce à des technologies innovantes d'illumination, sont transformés en des objets de charme recherché et d'une richesse individuelle.

000
000 → Numero di pagina del catalogo
Catalogue page number
Katalogseite
Numéro de page

! → Verificare le caratteristiche del prodotto e le condizioni di utilizzo sul manuale tecnico.
Check product information and using instructions on the technical handbook.
Produkteigenschaften und Gebrauchsbedingungen im technischen Handbuch prüfen.
Vérifier les caractéristiques du produit et ses conditions d'utilisation dans le manuel technique.



00
00 → Identificativo prodotto
Product reference mark
Produktidentifikation
Identification du produit



Alternative Interior Lighting

105
→

104
105



00





→12 04



→12 03



→12 01



→12 05



→12 02

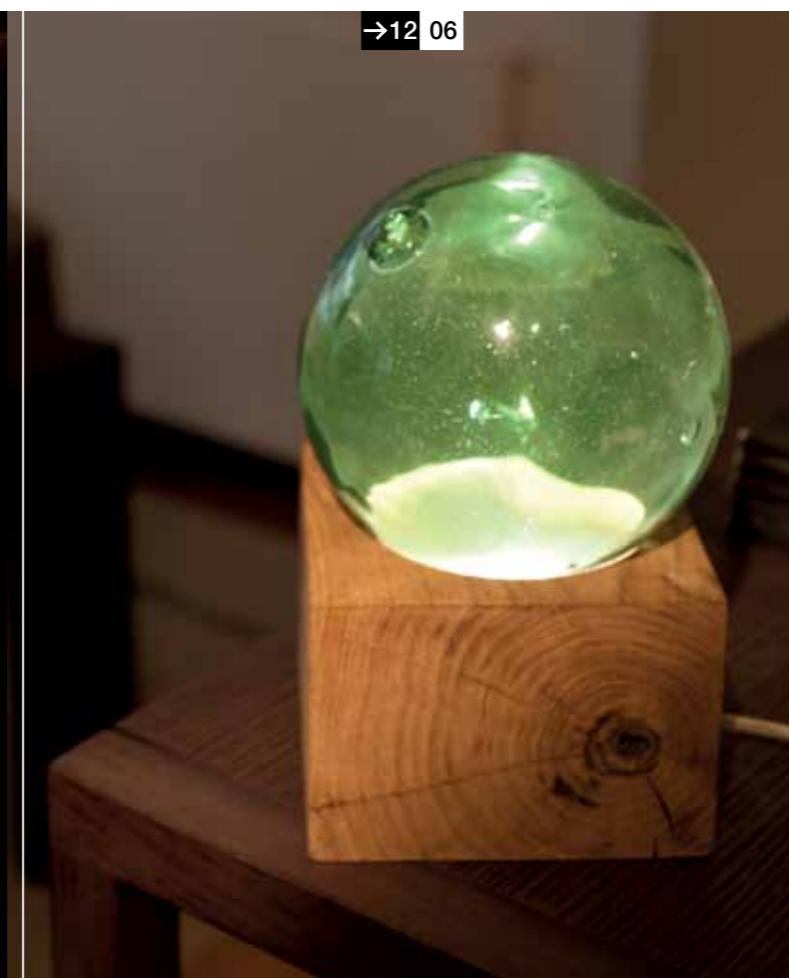

→12 06



→12 07

Il manuale tecnico e l'elenco dei componenti sono disponibili sul sito www.tahuma.it

Tahuma technical handbook and components list available on the web site www.tahuma.it

Das technische Handbuch und die Liste der Komponenten finden Sie auf unserer Website: www.tahuma.it

Le manuel technique et la liste des pièces sont disponibles sur le site www.tahuma.it

Concept:

Ricci Massimo

Studio di progettazione, esecuzione e gestione dell'immagine e della comunicazione aziendale integrata.

www.ricimassimografica.it

Photo:
Carlo Zuccoli

Printed in Italy
Edition: 01/2012

Editoria Grafica Colombo

I contenuti del presente catalogo sono tutelati dal diritto d'autore. È vietata la riproduzione e l'uso di testi ed immagini senza l'autorizzazione scritta di Tahuma s.r.l.

All the contents of this catalogue are subject to intellectual property rules. It is forbidden to copy and use texts and images without a written authorization of Tahuma s.r.l.

Der Inhalt des vorliegenden Katalogs ist urheberrechtlich geschützt. Die Vervielfältigung und die Verwendung der Texte und der Fotos ist ohne vorherige schriftliche Zustimmung von Tahuma s.r.l. verboten.

Les contenus de ce catalogue sont protégés par le droit d'auteur. Il est interdit de reproduire ou d'utiliser des textes et des images sans l'autorisation écrite de Tahuma s.r.l.

tahuma

Alternative Interior Decoration
Alternative Interior Exposition
Alternative Interior Lighting

